

STRATUS Multi-Deck Display Case

Installation and Operation Manual



KYSOR WARREN



September 2019

Part No. 31E01048

Models:

SX2LG, SX2LN, SX2LP, SX2XN

Applications:



Introduction—General Information	2
Plan and Cross Views	3
Case Data	5
Case Installation	9
Electrical Connections—General	13
Refrigeration Piping and Dehydration	14
LED Angle Adjustment Instructions	17
Operation	18
Parts List	20
Warranty	20

Installation and Operation Manual

Introduction—General Information

This manual has been prepared for our customers and the personnel involved in installing and maintaining our cases.

Our STRATUS case line has been designed with a focus on things most important to your bottom line. Enhanced merchandise visibility, high energy efficiency, and merchandising flexibility have all merged in an attractive, modular design. Custom styles fit seamlessly into your floor plan and an eco-friendly design protects the environment while saving energy costs. The SX2 multi-deck case line is available in medium-temperature applications.

These cases should be installed and operated according to the instructions contained in this manual to ensure proper performance. They are designed for display of products in an air-conditioned store where temperature and humidity are maintained at a maximum of 75° dry-bulb temperatures and 55% relative humidity.

CAUTION: Failure to maintain maximum design conditions may result in operational issues such as the following: increased BTUH load, high product temperature, coil icing, product frosting, and external sweating.

The SX2 will accommodate up to 2 levels of product display shelving in addition to the deck pan level for greater merchandise visibility that grabs shoppers' attention. These cases offer exceptional display facing area and product pack-out in a case that is only 49" in height. The shelving is available in 12", 16", and 22" shelf depths.

Case Description

Model	Description
SX2LG	Sandwich, standard depth, two deck, low front, glass.
SX2LN	Sandwich, standard depth, two deck, low front, non-glass.
SX2LP	Sandwich, standard depth, two deck, low front, Plexiglas.
SX2XN	Sandwich, standard depth, two deck, medium front, non-glass.

Receiving/Shipping Damage/Lost Items

All equipment should be examined for shipping damage before and during unloading. If there is any damage, the carrier should be notified immediately and an inspection requested. The delivery receipt must be noted that the equipment was received damaged. If damage is of a concealed nature, you must contact the carrier within three (3) days following delivery. The consignee for all damages must file a claim with the carrier.

NOTE: All claims for shortages must be within 10 days after receipt of shipment.

Refrigerant

A variety of refrigerants can be used in the Kysor Warren cases provided the correct expansion valve is equipped with the case when ordered (i.e., R404A required for the end user requires specifying the correct expansion valve for R404A refrigerant when the order is placed). Multiple expansion valves are available, depending on end user refrigerant requirements. Expansion valves are supplied for the refrigerant specified on the original sales order.

In addition, cases can be modified in the field to allow changing the type of refrigerant used. This requires changing the expansion valve and distributor orifice that is currently equipped in the case. Contact your Kysor Warren Service Representative for additional information.

NOTE: Refer to Case Data Control Settings for refrigeration requirements.

Installation and Operation Manual

SX2 Plan View (Single Coil)

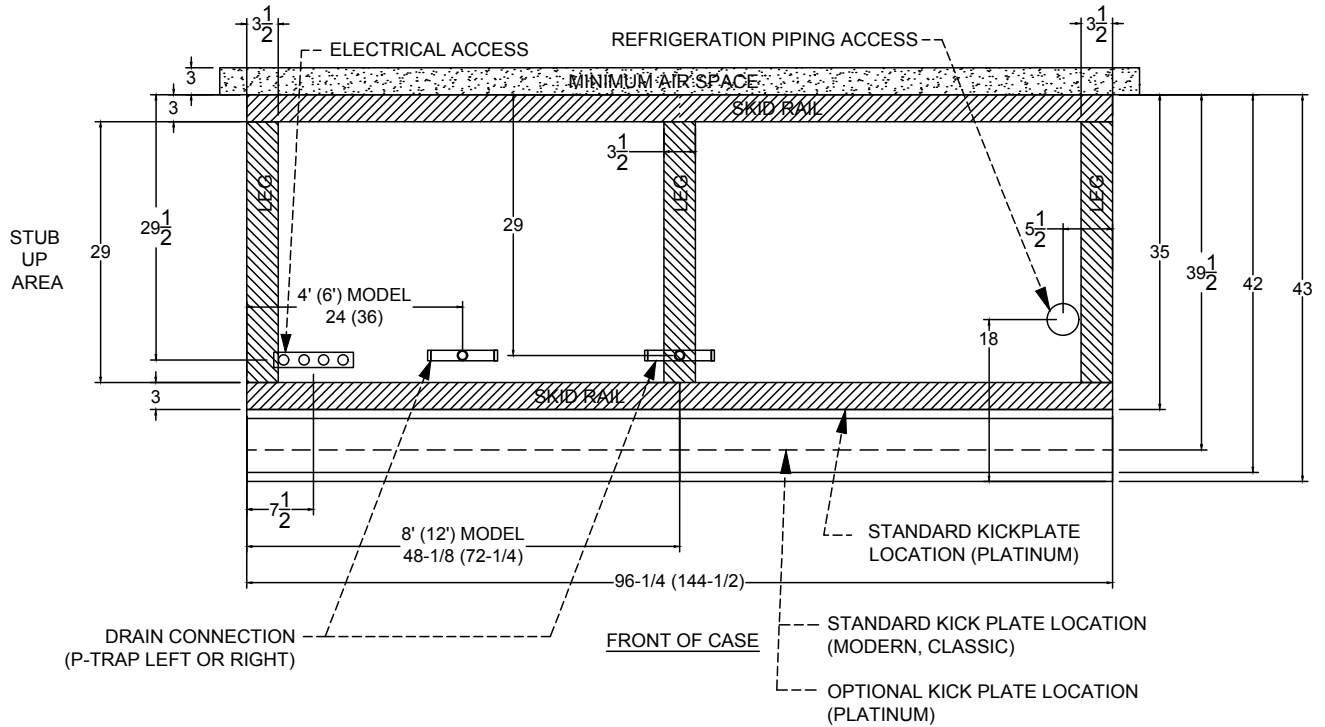

STRATUS Multi-Deck Display Case





Case Data

SX2LG - STRATUS

MULTI-DECK SPECIFICATION SHEET



KYSOR WARREN
eptarefrigeration

General Case Data	Case Length (ft)				APPLICATIONS	
	4'	6'	8'	12'		
Total Display Area (ft ²)	12.31	18.43	24.59	36.87	   	
Cubic Capacity (ft ³)	11.89	17.83	23.78	35.67		
Max Shelf Depth (in) [Top/Bottom]	12/16	12/16	12/16	12/16		
Weight (lb)	-	-	-	-		
Thermal Load (General)						
Discharge Air Velocity (fpm)	200	200	200	200		
Fan Speed (rpm)	1100	1100	1100	1100		
Discharge Air Temp (°F)	31	31	31	31		
Conventional Thermal Load, Single (Btuh) one row of canopy LED	3788	5682	7576	11364		
Parallel Thermal Load, Single (Btuh) one row of canopy LED	3508	5262	7016	10523		
Additional Btuh per ft LED - Canopy / Shelf & Nose	13 / 11	13 / 11	13 / 11	13 / 11		
Thermal Load (HFC)						
Evaporator Temperature (°F)	26	26	26	26		
Superheat Setpoint (°F)	6 - 8	6 - 8	6 - 8	6 - 8		
Estimated Refrigerant Charge (lbs)	1.241	1.846	2.579	3.925		
Thermal Load (Glycol)						
Supply Temperature (°F)	20	20	20	20		
Flow (GPM)	QTE	QTE	QTE	QTE		
Fluid %	35	35	35	35		
Pressure Drop (PSID)	QTE	QTE	QTE	QTE		
Electrical Data (Amps/Watts)						
115V/60Hz, 1 Phase						
Fans	0.10	0.19	0.19	0.29		
Canopy Lights (Per row)						
GE LED	0.22	0.33	0.44	0.67		
Shelf Lights (Per row)						
GE LED	0.08	0.10	0.15	0.23		

Defrost Data (off Cycle)			
Defrosts per Day	Failsafe Duration (min) ¹	Termination Temp (°F)	Drip Time (min)
6	18	50	2

¹ At ASHRAE conditions. For conditions above 75°F, 55% RH, increase defrost time by 15 min. Type I refrigerator, intended for use in an area where the environmental conditions are controlled and maintained that conditions do not exceed 75°F and 55% relative humidity. Kysor Warren, whose policy is one of continuous improvement, reserves the right to change at any time specifications, designs, or prices without incurring obligation. DOE 2017 Compliant



ANSI / NSF 7
The above case model has case lengths that are UL and NSF approved.

Installation and Operation Manual





Case Data

SX2LN - STRATUS

MULTI-DECK SPECIFICATION SHEET



KYSOR WARREN
eptarefrigeration

General Case Data	Case Length (ft)				APPLICATIONS	
	4'	6'	8'	12'		
Total Display Area (ft ²)	12.31	18.43	24.59	36.87	   	
Cubic Capacity (ft ³)	11.89	17.83	23.78	35.67		
Max Shelf Depth (in) [Top/Bottom]	12/16	12/16	12/16	12/16		
Weight (lb)	-	-	-	-		
Thermal Load (General)						
Discharge Air Velocity (fpm)	200	200	200	200		
Fan Speed (rpm)	1100	1100	1100	1100		
Discharge Air Temp (°F)	31	31	31	31		
Conventional Thermal Load, Single (Btuh) one row of canopy LED	3812	5718	7624	11436		
Parallel Thermal Load, Single (Btuh) one row of canopy LED	3530	5295	7060	10590		
Additional Btuh per ft LED - Canopy / Shelf & Nose	13 / 11	13 / 11	13 / 11	13 / 11		
Thermal Load (HFC)						
Evaporator Temperature (°F)	26	26	26	26		
Superheat Setpoint (°F)	6 - 8	6 - 8	6 - 8	6 - 8		
Estimated Refrigerant Charge (lbs)	1.241	1.846	2.579	3.925		
Thermal Load (Glycol)						
Supply Temperature (°F)	20	20	20	20		
Flow (GPM)	QTE	QTE	QTE	QTE		
Fluid %	35	35	35	35		
Pressure Drop (PSID)	QTE	QTE	QTE	QTE		
Electrical Data (Amps/Watts)						
115V/60Hz, 1 Phase						
Fans	0.10	0.19	0.19	0.29		
Canopy Lights (Per row)						
GE LED	0.22	0.33	0.44	0.67		
Shelf Lights (Per row)						
GE LED	0.08	0.10	0.15	0.23		

Defrost Data (off Cycle)			
Defrosts per Day	Failsafe Duration (min) ¹	Termination Temp (°F)	Drip Time (min)
6	18	50	2

¹ At ASHRAE conditions. For conditions above 75°F, 55% RH, increase defrost time by 15 min. Type I refrigerator, intended for use in an area where the environmental conditions are controlled and maintained that conditions do not exceed 75°F and 55% relative humidity. Kysor Warren, whose policy is one of continuous improvement, reserves the right to change at any time specifications, designs, or prices without incurring obligation. DOE 2017 Compliant



ANSI / NSF 7
The above case model has case lengths that are UL and NSF approved.

STRATUS Multi-Deck Display Case





Case Data

SX2LP - STRATUS

MULTI-DECK SPECIFICATION SHEET



KYSOR WARREN
eptarefrigeration

General Case Data	Case Length (ft)				APPLICATIONS	
	4'	6'	8'	12'		
Total Display Area (ft ²)	12.31	18.43	24.59	36.87	   	
Cubic Capacity (ft ³)	11.89	17.83	23.78	35.67		
Max Shelf Depth (in) [Top/Bottom]	12/16	12/16	12/16	12/16		
Weight (lb)	-	-	-	-		
Thermal Load (General)						
Discharge Air Velocity (fpm)	200	200	200	200		
Fan Speed (rpm)	1100	1100	1100	1100		
Discharge Air Temp (°F)	31	31	31	31		
Conventional Thermal Load, Single (Btuh) one row of canopy LED	3788	5682	7576	11364		
Parallel Thermal Load, Single (Btuh) one row of canopy LED	3508	5262	7016	10523		
Additional Btuh per ft LED - Canopy / Shelf & Nose	13 / 11	13 / 11	13 / 11	13 / 11		
Thermal Load (HFC)						
Evaporator Temperature (°F)	26	26	26	26		
Superheat Setpoint (°F)	6 - 8	6 - 8	6 - 8	6 - 8		
Estimated Refrigerant Charge (lbs)	1.241	1.846	2.579	3.925		
Thermal Load (Glycol)						
Supply Temperature (°F)	20	20	20	20		
Flow (GPM)	QTE	QTE	QTE	QTE		
Fluid %	35	35	35	35		
Pressure Drop (PSID)	QTE	QTE	QTE	QTE		
Electrical Data (Amps/Watts)						
115V/60Hz, 1 Phase						
Fans	0.10	0.19	0.19	0.29		
Canopy Lights (Per row)						
GE LED	0.22	0.33	0.44	0.67		
Shelf Lights (Per row)						
GE LED	0.08	0.10	0.15	0.23		

Defrost Data (off Cycle)			
Defrosts per Day	Failsafe Duration (min) ¹	Termination Temp (°F)	Drip Time (min)
6	18	50	2

¹ At ASHRAE conditions. For conditions above 75°F, 55% RH, increase defrost time by 15 min. Type I refrigerator, intended for use in an area where the environmental conditions are controlled and maintained that conditions do not exceed 75°F and 55% relative humidity. Kysor Warren, whose policy is one of continuous improvement, reserves the right to change at any time specifications, designs, or prices without incurring obligation. DOE 2017 Compliant



ANSI / NSF 7
The above case model has case lengths that are UL and NSF approved.

Installation and Operation Manual

Case Data

SX2XN - STRATUS

MULTI-DECK SPECIFICATION SHEET



KYSOR WARREN
eptarefrigeration

General Case Data	Case Length (ft)				APPLICATIONS
	4'	6'	8'	12'	
Total Display Area (ft ²)	11.47	17.18	22.92	34.36	
Cubic Capacity (ft ³)	11.89	17.83	23.78	35.67	
Max Shelf Depth (in) [Top/Bottom]	12/16	12/16	12/16	12/16	
Weight (lb)	-	-	-	-	
Thermal Load (General)					
Discharge Air Velocity (fpm)	200	200	200	200	
Fan Speed (rpm)	1100	1100	1100	1100	
Discharge Air Temp (°F)	31	31	31	31	
Conventional Thermal Load, Single (Btuh) one row of canopy LED	3752	5628	7504	11256	
Parallel Thermal Load, Single (Btuh) one row of canopy LED	3475	5212	6949	10424	
Additional Btuh per ft LED - Canopy / Shelf & Nose	13 / 11	13 / 11	13 / 11	13 / 11	
Thermal Load (HFC)					
Evaporator Temperature (°F)	26	26	26	26	
Superheat Setpoint (°F)	6 - 8	6 - 8	6 - 8	6 - 8	
Estimated Refrigerant Charge (lbs)	1.241	1.846	2.579	3.925	
Thermal Load (Glycol)					
Supply Temperature (°F)	20	20	20	20	
Flow (GPM)	QTE	QTE	QTE	QTE	
Fluid %	35	35	35	35	
Pressure Drop (PSID)	QTE	QTE	QTE	QTE	
Electrical Data (Amps/Watts)					
115V/60Hz, 1 Phase					
Fans	0.10	0.19	0.19	0.29	
Canopy Lights (Per row)					
GE LED	0.22	0.33	0.44	0.67	
Shelf Lights (Per row)					
GE LED	0.08	0.10	0.15	0.23	

Defrost Data (off Cycle)

Defrosts per Day	Failsafe Duration (min) ¹	Termination Temp (°F)	Drip Time (min)
6	18	50	2

¹ At ASHRAE conditions. For conditions above 75°F, 55% RH, increase defrost time by 15 min. Type I refrigerator, intended for use in an area where the environmental conditions are controlled and maintained that conditions do not exceed 75°F and 55% relative humidity. Kysor Warren, whose policy is one of continuous improvement, reserves the right to change at any time specifications, designs, or prices without incurring obligation. DOE 2017 Compliant



ANSI / NSF 7

The above case model has case lengths that are UL and NSF approved.

STRATUS Multi-Deck Display Case

NOTE: For sizing conventional/individual condensing units, add 8% to BTUH load.

NOTE: Where termination temperatures are given, mechanical defrost termination is required.

NOTE: Electrical data voltage is 115/60/1.

NOTE: When using night curtains, terminate with a 30 minute fail safe and 47°F termination temp.

Maximum Shelving Size Recommended: Not to exceed 22"

NOTE: The air current is very important to the performance of this case. The load limit line (see operation section) is the indicator of the inside edge of the air current and at no time should shelving, product, signs, debris, etc., interfere with air current.

NOTE: Temperature is measured in discharge air. Defrost frequency is at design conditions. Higher temperature or humidity may require more defrost and longer fail-safes. These cases are not designed to operate in environments where the ambient temperature is greater than 75°F and the relative humidity is greater than 55%.

NOTE: Off-cycle defrost is the recommended defrost for medium temp cases. Hot gas or Electrical defrost is the recommended defrost for low temp cases. There are some exceptions, please refer to Case Data Plate. Refer to www.kysorwarren.com for other electrical data and information.

CAUTION: Failure to maintain maximum design conditions may result in operational issues such as the following: increased BTUH load, high product temperature, coil icing, product frosting, and external sweating.

CAUTION: Failure to properly install electrical wiring and control wiring as per wiring diagram(s), defrost settings, and temperature set-points may result in operational issues such as: increased BTUH load, high product temperature, coil icing, product frosting, and external sweating.

Case Installation

These display cases may be installed individually or in a continuous line up consisting of several 4', 6', 8', and 12' sections using a joint kit. A Plexiglas divider kit must be used between cases operating on different refrigeration systems. The divider will be factory installed if specified on order.

Preparation—Prepare the installation area as follows:

1. Clean area where case is to be installed.
2. Verify installation area is at least 15 feet from any outside entrances or heating and cooling outlets.
3. Verify at least 2 feet of distance between hot and cold cases.
4. Ensure floor loading will support the case and the case contents.
5. Ensure proper AC power is available. Refer to case AC input requirements located in the electrical connections section of this manual.
6. Ensure location will allow connection to drain lines and the drain line, when installed, will meet the recommendations as set forth in the refrigeration piping and dehydration section of this manual.
7. Ensure expansion valve in case is the proper valve for the type of refrigerant used at the installation site.

CAUTION: To prevent condensation on the end panels of cases, a minimum of 3.0 inches between walls or other cases is required for airflow. If 3.0 inches is not possible, then the space between the cases must be completely filled and sealed or an updraft fan kit must be installed to provide air circulation through the space.

Installation

The following instructions are provided for unpacking, moving, loading, and lifting the case prior to installation.

NOTE: READ ALL INSTRUCTIONS CAREFULLY BEFORE BEGINNING INSTALLATION.

Installation and Operation Manual

Unpacking

WARNING: Use caution when removing the strapping in the following procedure, as the shelves are very heavy and could fall causing personal injury or equipment damage.

1. Remove all shipping tape from lamps and ensure that all lamp ends are snapped in place.
2. Ensure the evaporator cover is installed correctly with the deck pans installed.
3. Move the case into position, install, adjust superheat, and perform the operational checkout procedures following the instructions within this manual.

CAUTION: Be careful not to damage the factory-installed end while moving the case. Use the case lift points on the case to move it to the proper location.

Installing First Case

1. Ensure all preparation for installation, as outlined in the above paragraphs, have been fully complied with and are complete.
2. If multiple cases are to be installed, find the highest area of the floor to place the first case.
3. All cases must be located on a firmly based floor and be leveled within plus or minus 1/16 inch.
4. Use metal shims where required to support entire length of the case(s) at each base leg (front and back). All base legs must be shimmed under the skid rail where the base leg meets the lower rails (typically every 4' on 4' and 8' cases, and every 6' on 6' and 12' cases). If the case is equipped with adjustable leveling legs, all legs should be adjusted so that all are making equal contact with the floor for equal weight distribution.
WARNING: If any part of the case rail or leveling leg is not supported at each base leg, the case can appear out of level or become damaged when product weight is added.
5. If multiple cases are to be installed, refer to the floor plan and install the first case in the lineup by snapping a chalk line where the front and rear of the cases are to be located.
6. Continue the chalk line if multiple cases are to be installed. The first case is typically the case that is at the highest area on the floor.
7. Connect water drain line. Reference waste outlet (drip pipe) description and location procedure later in this chapter.
8. Connect input AC power. Reference electrical installation procedure later in this manual.
9. Connect refrigerant lines. Reference procedure later in this manual.
10. Install all ends, caps, and trim per the applicable instructions contained in this manual.
11. Remove shipping tape on fluorescent lamps and remove all other shipping material.
12. Refer to the operational start up procedures later in this manual. If multiple cases are to be installed, refer to the following paragraph for installing subsequent cases.

CASES MUST BE LEVELED FROM FRONT TO BACK AND END-TO-END AND SUPPORTED CONTINUOUSLY AS NEEDED WITH SHIMS

STRATUS Multi-Deck Display Case

Installing Subsequent Cases

NOTE: All cases are factory numbered with line up and position numbers. Make sure that cases are installed in order (line up sticker found on the fan plenum or door and on the back panel of the case).

If additional cases are to be installed, follow the same procedures as described in the installing first case procedure (above), in addition to the following:

1. Move cases as near their permanent location as possible before removing shipping braces, skids, or rollers.
2. Remove skids, shipping braces and optional casters, if provided.
3. Ensure all case expansion valves are correct.
4. Do not install electrical, drain lines, or refrigerant lines until all the cases have been set/placed into position and properly leveled.
5. Do not install case trim, ends, or caps until all cases have been set/placed into position and properly leveled.
6. Before lining up cases using the front and rear edges as a baseline, inspect refrigeration lines, electrical connections and controls to insure cases are in proper line up and are in proper sequence.
7. Remove shipping tape on fluorescent lamps and remove all other shipping material. Follow all joining to connect cases in a line-up.

Joining Instructions

Two or more cases of like models can be joined together to form a continuous line up. Before lining up cases, inspect refrigeration lines, electrical connections and controls to ensure cases are in the proper line-up and are in the proper sequence. Reference and become familiar with the below figure, and then join the cases using the instructions that follow.

Line Up Bolt Holes on Side of Cases—See Caulking Diagram Below

1. A mutual end and EPR valve must be used when joining a STRATUS case with a non-STRATUS case, or apply foam insulation tape and caulking around the side of the case as shown in Figure 1.

2. Next, remove access covers and back panels. The back panel is removed by lifting it upward and outward from the bottom and then dropping it down. Line up holes and insert the small lineup bolts (see diagram) in the end frame in the bolt-hole pattern. Place the special T-nut washer on the 3/8" machine bolt with the hollow section away from the bolt head. Tighten the 3/8" bolts with nut washer into the T-nuts alternately until cases are pulled up tight and the joint is completely sealed. (Reasonable care should be exercised in this procedure to prevent end frame distortion.)

Assist pulling case up tight by bumping from opposite end of case or by using pry bar.

3. Inspect joint for proper air and watertight seal inside and outside the case.
4. Replace line up access cover plugs and back panels.
5. Move cases as close together as possible and level by using the shims provided (same as original case). Use shelf standard struts for alignment to be sure cases are level.

FIGURE 1

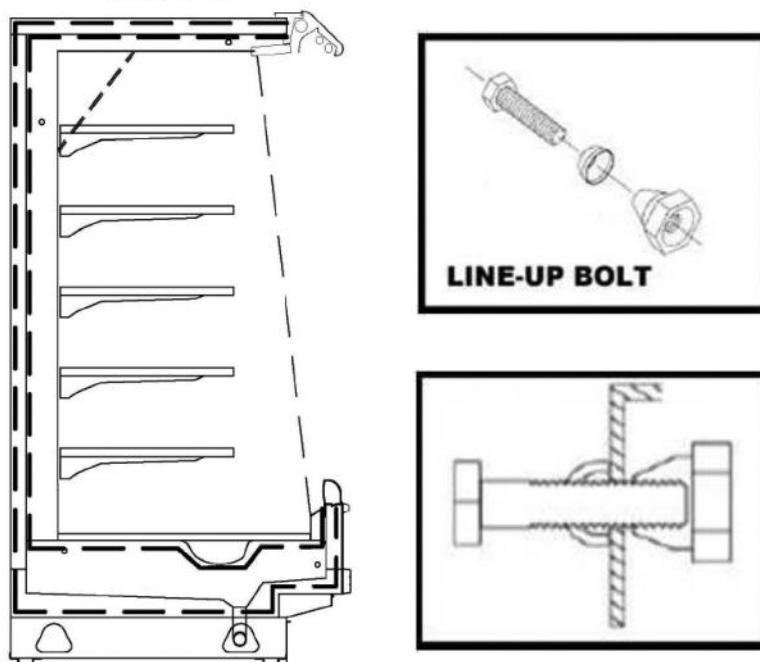

Installation and Operation Manual

CASES MUST BE LEVELED FROM FRONT TO BACK AND END-TO-END AND SUPPORTED CONTINUOUSLY AS NEEDED WITH SHIMS.

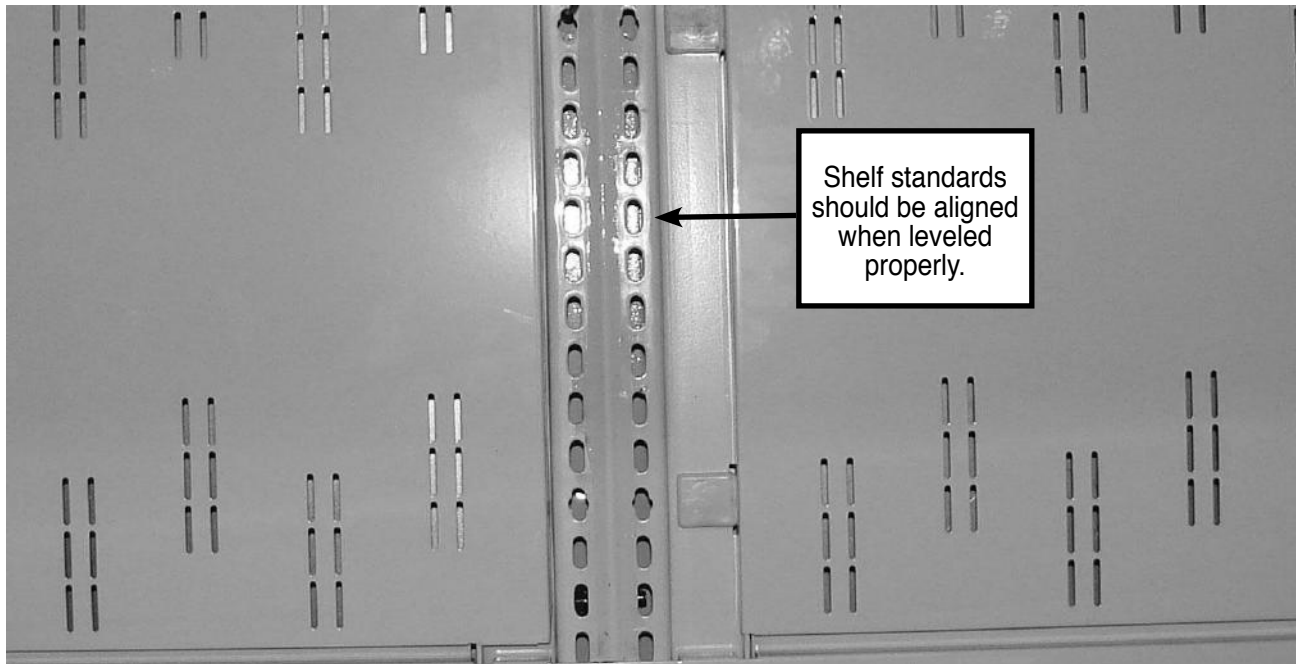

Waste Outlet (Drip Pipe) Description and Location

These cases are equipped with 1½" PVC waste outlet connection that terminates in the center of the 4', 6', 8' and 12' refrigerator below the insulated bottom. The water seal trap, elbow, and cap are shipped loose for field installation.

NOTE: Improperly installed drip pipes can seriously affect the operation of this case and result in increased maintenance cost. Listed below are some general rules for drip pipe installation.

- Never use a double water seal.
- Never use a pipe smaller than the size pipe or water seal supplied with the case.
- Always provide as much fall as possible in drip pipe (1" fall for each 4' of drip pipe.)
- Avoid long runs in drip pipe, which make it impossible to provide maximum fall in pipe.
- Provide a drip space between drip pipe and floor drain or sewer connection.

Case Freezing

Do not allow drip pipe to come in contact with un-insulated suction lines, which will cause the condensation from your case to freeze.

Drain Strainer

NOTE: Not all Kysor Warren cases have drain strainers. This information applies only to the cases equipped with strainers.

The drain strainer is used to keep debris or any foreign objects from entering the PVC drain, which could cause blockage. To install, insert into drain until drain strainer stops. It will not be flush. Strainer will exceed hub by 1". DO NOT flatten drain strainer.

NOTE: 1½" Drain Pipe

STRATUS Multi-Deck Display Case

Electrical Connections—General

CAUTION: Failure to properly install electrical wiring and control wiring as per wiring diagram(s), defrost settings, and temperature set-points may result in operational issues such as the following: increased BTUH load, high product temperature, coil icing, product frosting, and external sweating.

Wiring Diagram—Off Cycle Defrost

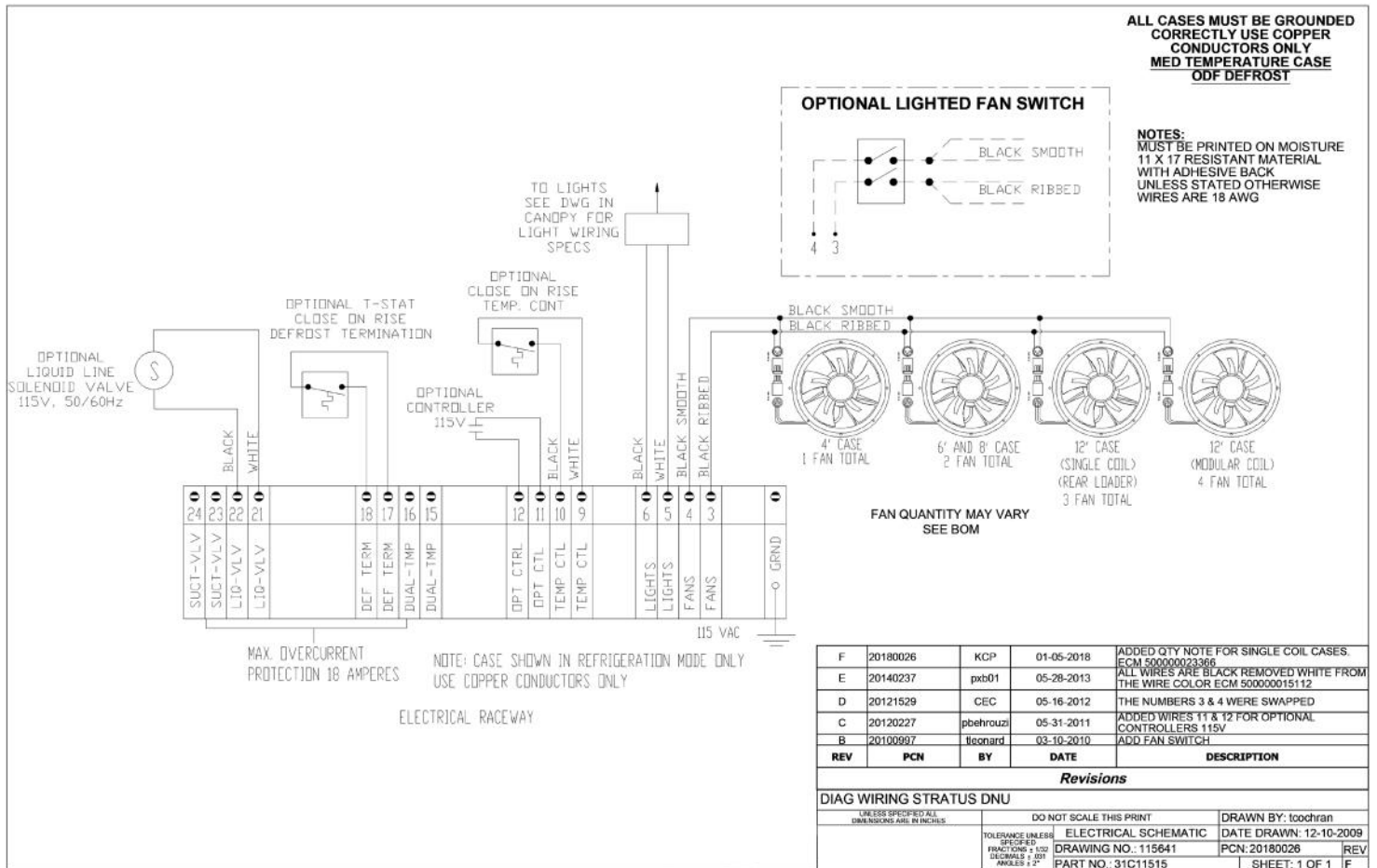

WARNING! Always disconnect the electrical power at the main disconnect when servicing or replacing any electrical component. This includes, but is not limited to, such items as fans, heaters, thermostats and light bulbs. Failure to disconnect the electrical power may result in personal injury or death.

The wires are clearly identified for termination purposes as follows:

Component	Wire Number
Anti-Sweat Heater	1 and 2
Refrigerator Fan Motors and Drain Heater	3 and 4
Lighting Circuit	5 and 6
Defrost Heaters	7 and 8
Temperature Control	9 and 10
Dual Temperature	15 and 16
Defrost Termination Control	17 and 18

Installation and Operation Manual

Refrigeration Piping and Dehydration

Opening a Ferrule Hole

The refrigeration lines are located under the deck pans. A refrigeration outlet is provided in the front right hand end of the cases. All refrigeration lines need to be as close to the drain pan as possible so as not to obstruct the air pattern or block the deck pans.

NOTE: Cases are single coil with single valve piping.

Recommended Piping Instruction

1. Proper size refrigeration lines are essential to good refrigeration performance. Suction lines are more critical than liquid or discharge lines. Oversized suction lines may prevent good oil return to the compressor. Under-sized lines can rob refrigeration capacity and increase operating cost. Consult the technical manual or legend sheet for proper line sizes.
2. Refrigeration lines in cases in line-ups can be reduced. However, the lines should be no smaller than the main trunk lines in at least 1/3 of the cases and no smaller than one size above the case lines to the last case. Reductions should not exceed one line size per case. It is preferred to bring the main trunk lines in at the center of line-up. Liquid lines on systems on hot gas defrost must be increased one line size above the main trunk line for the entire line-up. Individual feed lines should be at the bottom of the liquid header. (See proper liquid line piping diagram.)
3. Do not run refrigeration lines from one system through cases on another system.
4. Use dry nitrogen in lines during brazing to prevent scaling and oxidation.
5. Insulate suction lines from the cases to the compressor with 3/4" wall thickness foam on low temperature cases to provide maximum of 65-degree super heated gas back to the compressor and prevent condensation in exposed areas. Insulate suction lines on medium temperature cases with 1/2" thick insulation in exposed areas to prevent condensate drop-off.
6. Suction and liquid lines should never be taped or soldered together. Adequate heat exchanger is provided in the case. Kysor Warren recommends use of heat exchanger in all medium and low temperature cases that are not mechanically sub-cooled for proper operation.
7. Refrigeration lines should never be placed in the ground unless they are protected against moisture and electrolysis attack.
8. Always slope suction lines down toward the compressor, 2" each 10'. Do not leave dips in the line that would trap oil.
9. Provide P traps at the bottom of suction line risers, 4' or longer. Use a double P trap for each 20' of risers. P traps should be the same size as the horizontal line. Consult the technical manual or legend sheet for proper size risers.
10. Use long radius ells and avoid 45 degree ells.
11. Provide expansion loops in suction lines on systems on hot gas defrost. An expansion loop is required for each 100' of straight run.
12. Strap and support tubing to prevent excessive line vibration and noise.
13. Brazing of copper to copper should be with a minimum of 10% silver. Copper to brass or copper to steel should be with 45% silver.
14. Do not use bullhead tees in suction lines. An example is where suction gas enters both ends of the tee and exits the center. This can cause a substantial increase in pressure drop in the suction lines.
15. When connecting more than one suction line to a main trunk line, connect each branch with an inverted trap.

Suction Line

1. Pitch in direction of flow.
2. Suction lines should enter at the top of the branch line.
3. May be reduced by one size at one third of case run load and after the second third. DO NOT reduce below the case suction line size.

Installation and Operation Manual

Expansion Valve and Superheat

CAUTION: During service of this equipment, precautions should be taken to prevent loss of refrigerant to the atmosphere. Always install the expansion valve stem cap after making valve adjustments.

The expansion valve furnished with your case has been sized for maximum coil efficiency. To adjust superheat, perform the following:

1. Place a thermocouple near the expansion valve bulb. Read the suction line pressure as near coil as possible. If closest is at the condensing unit, estimate suction line loss at 2 PSIG.
2. Convert coil suction pressure to temperature. The difference between coil temperature and the thermocouple temperature is superheat. Use average superheat when expansion valve is hunting.
3. Do not set the superheat until cases have pulled down to operating temperature and never open or close the valve over $\frac{1}{4}$ turn between adjustments and allow 10 minutes or more between adjustments.
4. Superheat should be set at 6–8°F.
5. After the initial setting, the superheat should be rechecked when product is stocked and at designed temperature.

Superheat Calculations

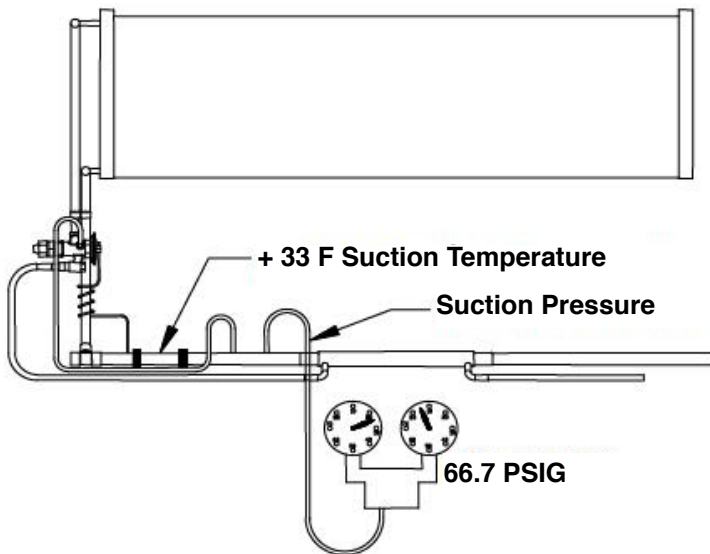

Example: R404

+ 33 F Suction Temperature

+ 28 F Suction Pressure Converted to Temperature

= +5 F Superheat

LED Angle Adjustment Instructions

1. Isolate Mains Supply.

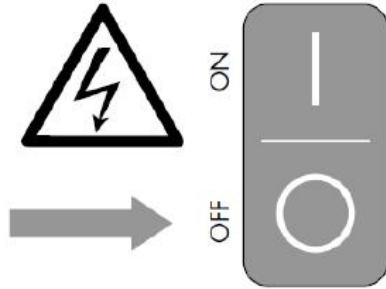

2. Remove luminaire.

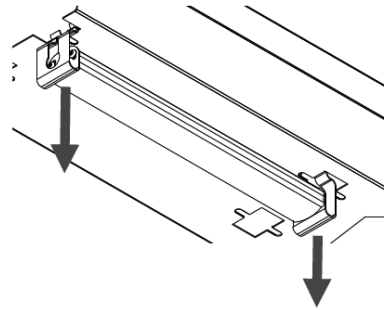

3. Check indicator tab for current angle setting.

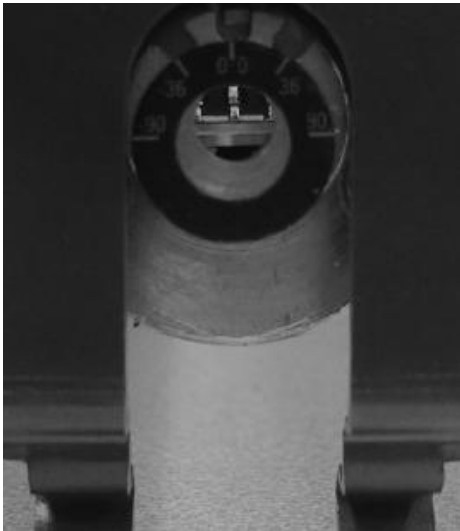

4. Push up on tabs and pull the indicator tab away from the angle dial.

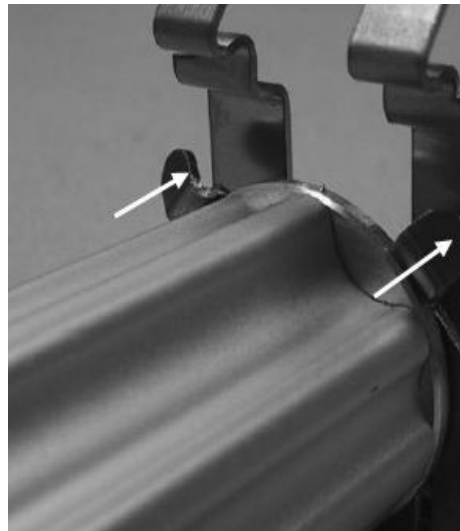

5. Twist cap to desired angle.

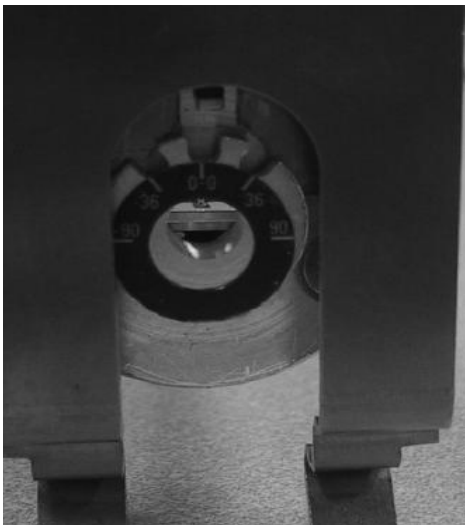

6. Press cap back into place.

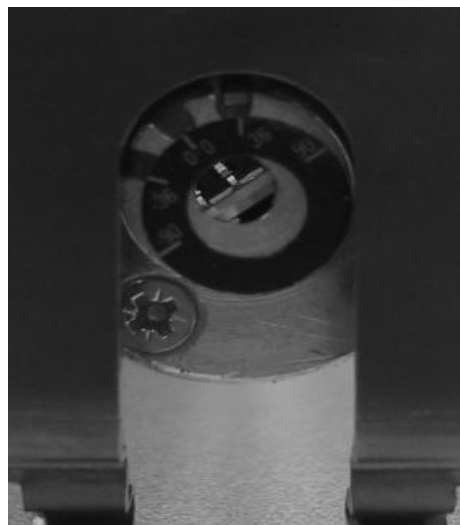

7. Replace luminaire.

8. Reconnect mains supply.

Installation and Operation Manual

Operation

Merchandise should not be placed in the fixture until all controls have been adjusted and the case is at the proper temperature. AT NO TIME SHOULD THE CASE BE STOCKED BEYOND THE LOAD LINE OR OVER THE FRONT EDGE OF THE ADJUSTABLE SHELVES.

CAUTION: Air discharge and return flues must remain open and free of debris or obstruction at all times to provide proper refrigeration and air current performance.

CAUTION: Do not allow any product, signs, debris, etc., to block these grilles.

CAUTION: Do not use any non-approved shelving, display racks, or any accessory that could hamper air current performance.

1. Off-Cycle Defrost is standard on these models. The fans run continuously and defrost termination is by termination Klixon.
2. Single Condensing Case Systems – A thermostat should be used to control case temperatures. The thermostat bulb should be mounted in the discharge air (see case data if your case is a single condensing case system).

NOTE: Where termination temperatures are given, mechanical defrost termination is required.

Cleaning

As a general rule, always use mild soap and water to wipe the case down, including the sliding doors at the back of the case. Special precautions must be taken when cleaning some components of the case.

Exterior surfaces should be cleaned with warm water and mild soap to protect and maintain the finish. Do not use cleaners containing abrasive materials or ammonia, which will scratch or dull the finish. The waste outlet should be flushed with water following each cleaning.

Interior surfaces may be cleaned with most mild soap formulas, ammonia based cleaners, and sanitizing solutions with no harm to the surface.

WARNING! Always shut power off during the cleaning process. Cleaning the case with electrical power applied is a shock hazard that may cause serious injury or death.

WARNING! DO NOT USE HOT WATER ON COLD GLASS SURFACES. This could cause the glass to shatter and could result in personal injury. Glass fronts and ends should be warm before applying hot water.

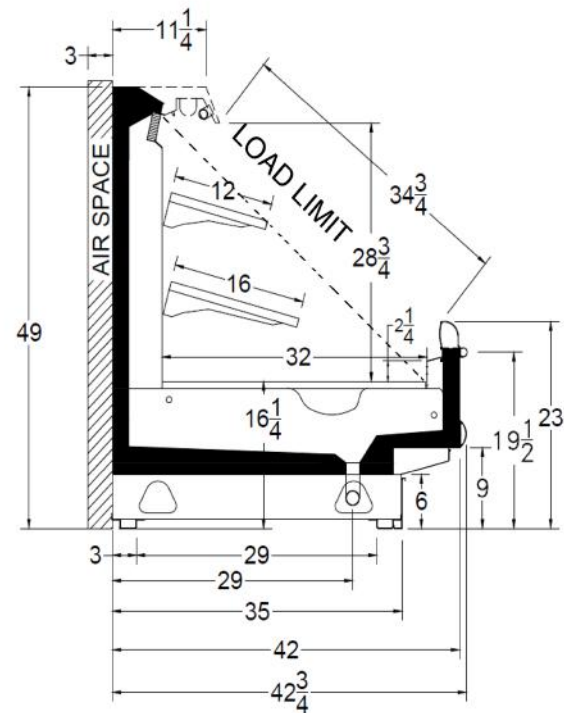

STRATUS Multi-Deck Display Case

CAUTION—The following could damage the case:

- Use of cleaning products containing chlorine, chloride ion, the words Bleach, is not recommended for unpainted stainless steel surfaces as it may cause rust to form. The operational warranty of the equipment will be voided if these products cause rust to form on the stainless steel parts or any other parts of the equipment.
- Do not use solvent, oil, or acidic-based cleaners on any interior surfaces as the surface may become damaged.
- Do not use abrasive cleaners and scouring pads, as these will mar the finish.
- Never introduce water into the case faster than the waste outlet can release it.
- Do not use steam or high pressure systems to clean the case, as seals may be broken which will cause the case to leak.

Shelves

Do not use a hose or submerge shelves in water. When cleaning lighted shelves wipe down the shelves with a wet sponge or cloth so that water does not enter the light rails.

Honeycomb Assembly

The honeycomb should be cleaned every 6–8 months, depending on store conditions. The honeycomb may be cleaned with a vacuum cleaner or removed to be washed with soap and water. The honeycomb must be completely dry before returning it to the case. Note the position and angle of the honeycomb when removing from the case. Honeycomb must be replaced at the same angle.

SCREWS

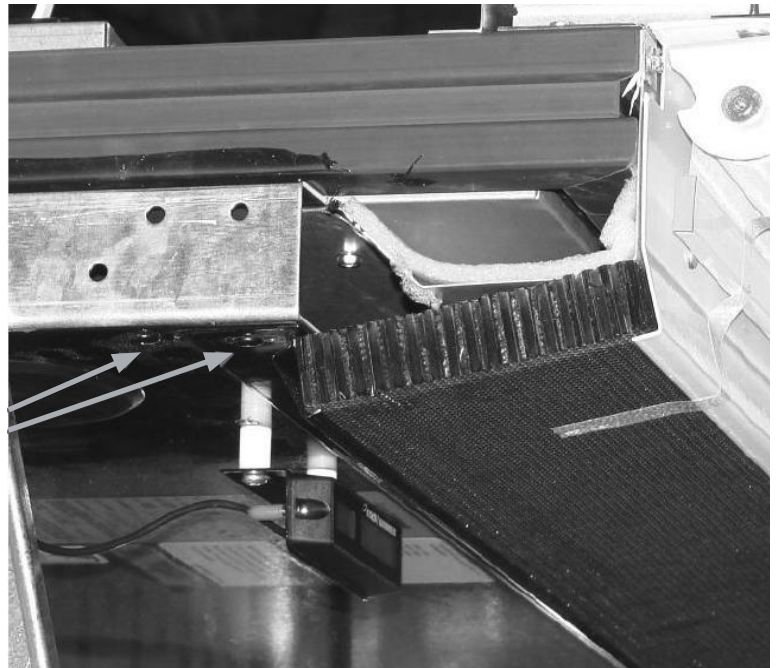

Installation and Operation Manual

Parts List

Common Replacement Parts

Description	Part No.	Quantity			
		4 FT	6 FT	8 FT	12 FT
Fan Motor ECM	09A10137	1	2	2	3
Deck Pan PTD	54N18237	2	3	4	6
Deck Pan BRT	55M16029	2	3	4	6

Description	Part No.			
	4 FT	6 FT	8 FT	12 FT
External Drain Trap	96H46371	96H46371	96H46371	96H46371

NOTE: Standard parts are provided in the parts lists. Cases may be equipped with specialty parts that were incorporated into the case(s) at the time they were manufactured. It is important to have the case serial number when contacting Kysor Warren for replacement parts.

Warranty

KYSOR WARREN EPTA US CORPORATION EQUIPMENT LIMITED WARRANTY

www.kysorwarren.com/warranty
for complete details



KYSOR WARREN

5201 Transport Blvd.
Columbus, GA 31907
P: 800.866.5596
F: 706.568.8990



www.kysorwarren.com