

# STRATUS Multi-Deck Display Case

# Installation and Operation Manual



## KYSOR WARREN



**June 2018**

**Part No. 31E02120**

**Models:  
DX5LN**

**Applications:**

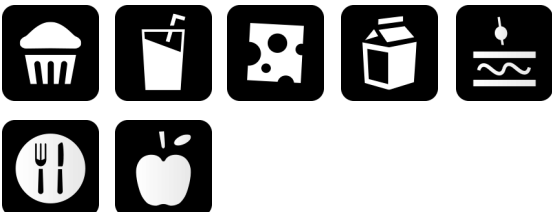

KW-IOM-2120 | Version 06

|                                      |    |
|--------------------------------------|----|
| Introduction—General Information     | 2  |
| Plan and Cross Views                 | 3  |
| Case Data                            | 4  |
| Case Installation                    | 5  |
| Electrical Connections—General       | 9  |
| Refrigeration Piping and Dehydration | 10 |
| LED Angle Adjustment Instructions    | 13 |
| ECM Evaporator Fan                   | 14 |
| Operation                            | 16 |
| Parts List                           | 18 |
| Warranty                             | 18 |

# Installation and Operation Manual

---

## Introduction—General Information

This manual has been prepared for our customers and the personnel involved in installing and maintaining our cases.

Our STRATUS case line has been designed with a focus on things most important to your bottom line. Enhanced merchandise visibility, high energy efficiency, and merchandising flexibility have all merged in an attractive, modular design. Custom styles fit seamlessly into your floor plan and an eco-friendly design protects the environment while saving energy costs. The DX5LN multi-deck is available in medium-temperature case applications.

These cases should be installed and operated according to the instructions contained in this manual to ensure proper performance. They are designed for display of products in an air-conditioned store where temperature and humidity are maintained at a maximum of 75° dry-bulb temperatures and 55% relative humidity.

**CAUTION:** Failure to maintain maximum design conditions may result in operational issues such as the following: increased BTUH load, high product temperature, coil icing, product frosting, and external sweating.

The DX5 will accommodate up to 4 levels of product display shelving in addition to the deck pan level for greater merchandise visibility that grabs shoppers' attention. These cases offer exceptional display facing area and product pack-out in a case that is only 80" in height. The shelving is available in 18", 20", 22", and 24" shelf depths.

## Case Description

| Model | Description   |
|-------|---|
| DX5LN | Dairy, standard depth, five deck, low front, non-glass. |

## Receiving/Shipping Damage/Lost Items

All equipment should be examined for shipping damage before and during unloading. If there is any damage, the carrier should be notified immediately and an inspection requested. The delivery receipt must be noted that the equipment was received damaged. If damage is of a concealed nature, you must contact the carrier within three (3) days following delivery. The consignee for all damages must file a claim with the carrier.

**NOTE:** All claims for shortages must be within 10 days after receipt of shipment.

## Refrigerant

A variety of refrigerants can be used in the Heatcraft cases provided the correct expansion valve is equipped with the case when ordered (i.e., R404A required for the end user requires specifying the correct expansion valve for R404A refrigerant when the order is placed). The correct expansion valve must be specified on the order to meet end user requirements. If none is specified on the order, the default expansion valve will be shipped with the case.

In addition, cases can be modified in the field to allow changing the type of refrigerant used. This requires changing the expansion valve and distributor orifice that is currently equipped in the case. Contact your Heatcraft Worldwide Refrigeration Service Representative for additional information.

**NOTE:** Refer to Case Data Control Settings for refrigeration requirements.

# STRATUS Multi-Deck Display Case

## Plan and Cross Views

DX5LN Cross View

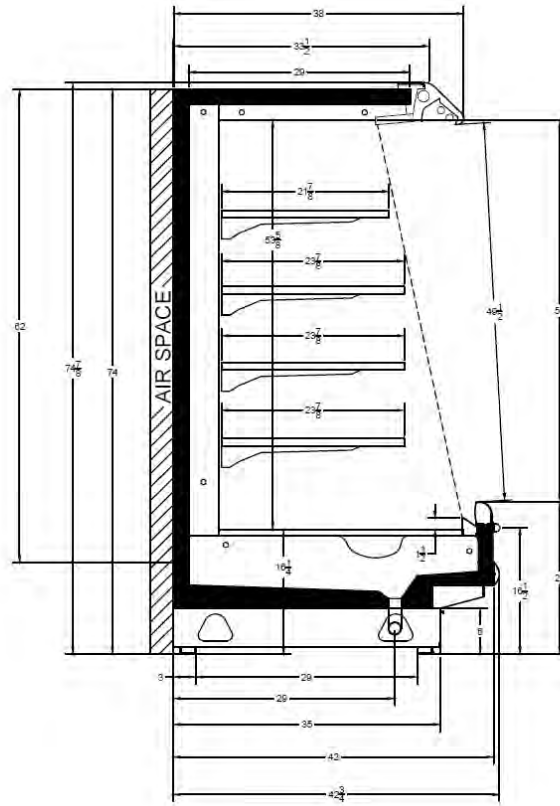

DX5LN Plan View

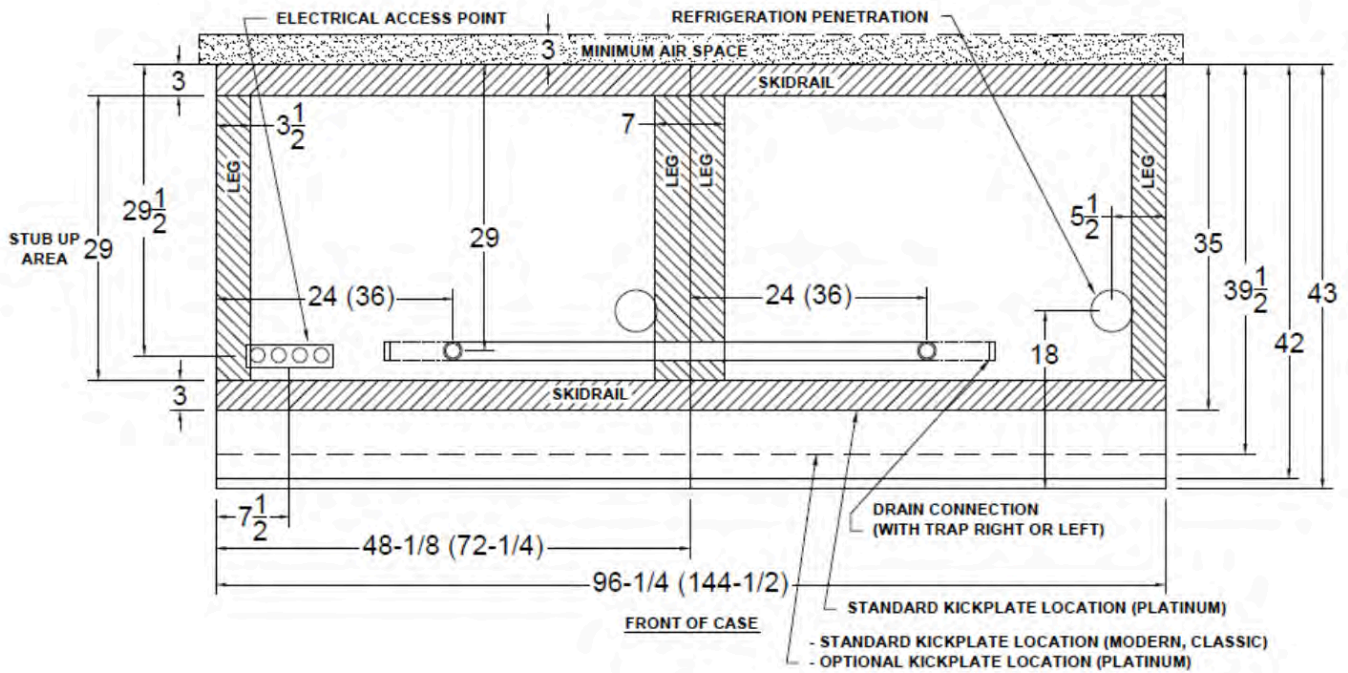

# Installation and Operation Manual

## Case Data

DX5LN

## Capacities

| Length (FT) | Facing Area (FT <sup>2</sup> ) | Cubic Capacity (FT <sup>3</sup> ) |
|-------------|--------------------------------|-----------------------------------|
| 4'          | 16.58                          | 39.5                              |
| 6'          | 24.83                          | 59.16                             |
| 8'          | 33.12                          | 78.91                             |
| 12'         | 49.67                          | 118.3                             |

## Refrigeration Data

| BTUH per FT of Case Unlighted Shelves One Row Canopy - LED Lights |        | BTUH per FT of Case Unlighted Shelves One Row Canopy - T8 Lights |        | Add BTUH per FT per Row Lighted Shelves |    | Add BTUH per FT per Row Nose Lights or Additional T8 Canopy Light |    | Evap. Temp. | Discharge Air |             |
|---|--------|--|--------|---|----|---|----|-------------|---------------|-------------|
| Parallel  | Single | Parallel   | Single | LED                                     | T8 | LED   | T8 |             | Temp          | Velocity    |
| 1091  | 1178   | 1097   | 1185   | 11                                      | 19 | 11  | 19 | +28°F       | +33°F         | 185-200 FPM |

Add 13 BTUH/FT for additional LED canopy light

## Electrical Data

| Length | ECM Fan Data |      | Shelf Light - Amps Per Lighted Shelf |      | Nose Light - Amps |      | Canopy Light - Amps |          |
|--------|--------------|------|--------------------------------------|------|-------------------|------|---------------------|----------|
|        | Fan Qty      | Amps | LED                                  | T8   | LED               | T8   | 1 Row LED           | 2 Row T8 |
| 4'     | 1            | 0.1  | 0.12                                 | 0.25 | 0.1               | 0.25 | 0.24                | 0.5      |
| 6'     | 2            | 0.2  | 0.09                                 | 0.22 | 0.18              | 0.44 | 0.37                | 0.88     |
| 8'     | 2            | 0.2  | 0.12                                 | 0.25 | 0.2               | 0.5  | 0.48                | 1        |
| 12'    | 4            | 0.4  | 0.12                                 | 0.25 | 0.36              | 0.75 | 0.72                | 1.5      |

## Defrost Data

| Defrost   | Per Day | Fail Safe | Termination |
|-----------|---------|-----------|-------------|
| Off Cycle | 6       | 18 min    | +47°F       |

NOTE: For sizing conventional/individual condensing units, add 8% to BTUH load.

NOTE: Where termination temperatures are given, mechanical defrost termination is required.

NOTE: Electrical data voltage is 115/60/1.

NOTE: When using night curtains, terminate with a 30 minute fail safe and 47°F termination temperature.

# STRATUS Multi-Deck Display Case

---

## Maximum Shelving Size Recommended: Not to exceed 22"

NOTE: The air current is very important to the performance of this case. The load limit line (see operation section) is the indicator of the inside edge of the air current and at no time should shelving, product, signs, debris, etc., interfere with air current.

NOTE: Temperature is measured in discharge air. Defrost frequency is at design conditions. Higher temperature or humidity may require more defrost and longer fail-safes. These cases are not designed to operate in environments where the ambient temperature is greater than 75°F and the relative humidity is greater than 55%.

NOTE: Off-cycle defrost is the recommended defrost for medium temp cases. Hot gas or Electrical defrost is the recommended defrost for low temp cases. There are some exceptions, please refer to Case Data Plate. Refer to [www.heatcraftprd.com](http://www.heatcraftprd.com) for other electrical data and information.

CAUTION: Failure to maintain maximum design conditions may result in operational issues such as the following: increased BTUH load, high product temperature, coil icing, product frosting, and external sweating.

CAUTION: Failure to properly install electrical wiring and control wiring as per wiring diagram(s), defrost settings, and temperature set-points may result in operational issues such as: increased BTUH load, high product temperature, coil icing, product frosting, and external sweating.

## Case Installation

These display cases may be installed individually or in a continuous line up consisting of several 4', 6', 8', and 12' sections using a joint kit. A Plexiglas divider kit must be used between cases operating on different refrigeration systems. The divider will be factory installed if specified on order.

### Preparation—Prepare the installation area as follows:

1. Clean area where case is to be installed.
2. Verify installation area is at least 15 feet from any outside entrances or heating and cooling outlets.
3. Verify at least 2 feet of distance between hot and cold cases.
4. Ensure floor loading will support the case and the case contents.
5. Ensure proper AC power is available. Refer to case AC input requirements located in the electrical connections section of this manual.
6. Ensure location will allow connection to drain lines and the drain line, when installed, will meet the recommendations as set forth in the refrigeration piping and dehydration section of this manual.
7. Ensure expansion valve in case is the proper valve for the type of refrigerant used at the installation site.

CAUTION: To prevent condensation on the end panels of cases, a minimum of 3.0 inches between walls or other cases is required for airflow. If 3.0 inches is not possible, then the space between the cases must be completely filled and sealed or an updraft fan kit must be installed to provide air circulation through the space.

## Installation

The following instructions are provided for unpacking, moving, loading, and lifting the case prior to installation.

NOTE: READ ALL INSTRUCTIONS CAREFULLY BEFORE BEGINNING INSTALLATION.

# Installation and Operation Manual

---

## Unpacking

**WARNING:** Use caution when removing the strapping in the following procedure, as the shelves are very heavy and could fall causing personal injury or equipment damage.

1. Remove all shipping tape from lamps and ensure that all lamp ends are snapped in place.
2. Ensure the evaporator cover is installed correctly with the deck pans installed.
3. Move the case into position, install, adjust superheat, and perform the operational checkout procedures following the instructions within this manual.

**CAUTION:** Be careful not to damage the factory-installed end while moving the case. Use the case lift points on the case to move it to the proper location.

## Installing First Case

1. Ensure all preparation for installation, as outlined in the above paragraphs, have been fully complied with and are complete.
2. If multiple cases are to be installed, find the highest area of the floor to place the first case.
3. All cases must be located on a firmly based floor and be leveled within plus or minus 1/16 inch.
4. Use metal shims where required to support entire length of the case(s) at each base leg (front and back). All base legs must be shimmed under the skid rail where the base leg meets the lower rails (typically every 4' on 4' and 8' cases, and every 6' on 6' and 12' cases). If the case is equipped with adjustable leveling legs, all legs should be adjusted so that all are making equal contact with the floor for equal weight distribution. **WARNING:** If any part of the case rail or leveling leg is not supported at each base leg, the case can appear out of level or become damaged when product weight is added.
5. If multiple cases are to be installed, refer to the floor plan and install the first case in the lineup by snapping a chalk line where the front and rear of the cases are to be located.
6. Continue the chalk line if multiple cases are to be installed. The first case is typically the case that is at the highest area on the floor.
7. Connect water drain line. Reference waste outlet (drip pipe) description and location procedure later in this chapter.
8. Connect input AC power. Reference electrical installation procedure later in this manual.
9. Connect refrigerant lines. Reference procedure later in this manual.
10. Install all ends, caps, and trim per the applicable instructions contained in this manual.
11. Remove shipping tape on fluorescent lamps and remove all other shipping material.
12. Refer to the operational start up procedures later in this manual. If multiple cases are to be installed, refer to the following paragraph for installing subsequent cases.

**CASES MUST BE LEVELED FROM FRONT TO BACK AND END-TO-END AND SUPPORTED CONTINUOUSLY AS NEEDED WITH SHIMS**

## Installing Subsequent Cases

**NOTE:** All cases are factory numbered with line up and position numbers. Make sure that cases are installed in order (line up sticker found on the fan plenum or door and on the back panel of the case).

If additional cases are to be installed, follow the same procedures as described in the installing first case procedure (above), in addition to the following:

1. Move cases as near their permanent location as possible before removing shipping braces, skids, or rollers.
2. Remove skids, shipping braces and optional casters, if provided.
3. Ensure all case expansion valves are correct.
4. Do not install electrical, drain lines, or refrigerant lines until all the cases have been set/placed into position and properly leveled.
5. Do not install case trim, ends, or caps until all cases have been set/placed into position and properly leveled.
6. Before lining up cases using the front and rear edges as a baseline, inspect refrigeration lines, electrical connections and controls to insure cases are in proper line up and are in proper sequence.
7. Remove shipping tape on fluorescent lamps and remove all other shipping material. Follow all joining to connect cases in a line-up.

# STRATUS Multi-Deck Display Case

## Joining Instructions

Two or more cases of like models can be joined together to form a continuous line up. Before lining up cases, inspect refrigeration lines, electrical connections and controls to ensure cases are in the proper line-up and are in the proper sequence. Reference and become familiar with the below figure, and then join the cases using the instructions that follow.

### Line Up Bolt Holes on Side of Cases—See Caulking Diagram Below

1. A mutual end and EPR valve must be used when joining a STRATUS case with a non-STRATUS case, or apply foam insulation tape and caulking around the side of the case as shown in Figure 1.
2. Next, remove access covers and back panels. The back panel is removed by lifting it upward and outward from the bottom and then dropping it down. Line up holes and insert the small lineup bolts (see diagram) in the end frame in the bolt-hole pattern. Place the special T-nut washer on the 3/8" machine bolt with the hollow section away from the bolt head. Tighten the 3/8" bolts with nut washer into the T-nuts alternately until cases are pulled up tight and the joint is completely sealed. (Reasonable care should be exercised in this procedure to prevent end frame distortion.)

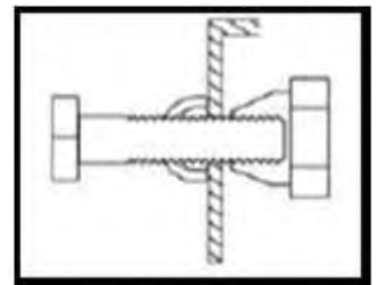
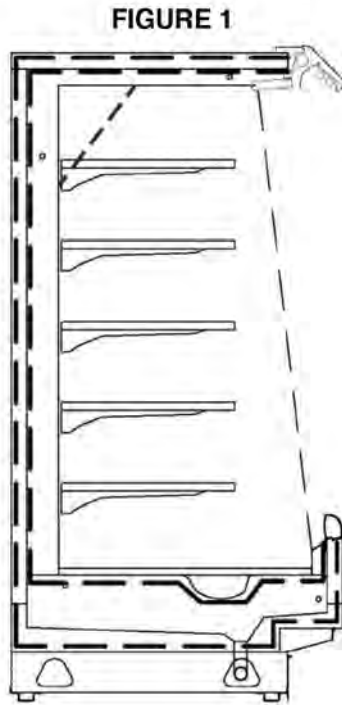

Assist pulling case up tight by bumping from opposite end of case or by using pry bar.

3. Inspect joint for proper air and watertight seal inside and outside the case.
4. Replace line up access cover plugs and back panels.
5. Move cases as close together as possible and level by using the shims provided (same as original case). Use shelf standard struts for alignment to be sure cases are level.

# Installation and Operation Manual

---

CASES MUST BE LEVELED FROM FRONT TO BACK AND END-TO-END AND SUPPORTED CONTINUOUSLY AS NEEDED WITH SHIMS.

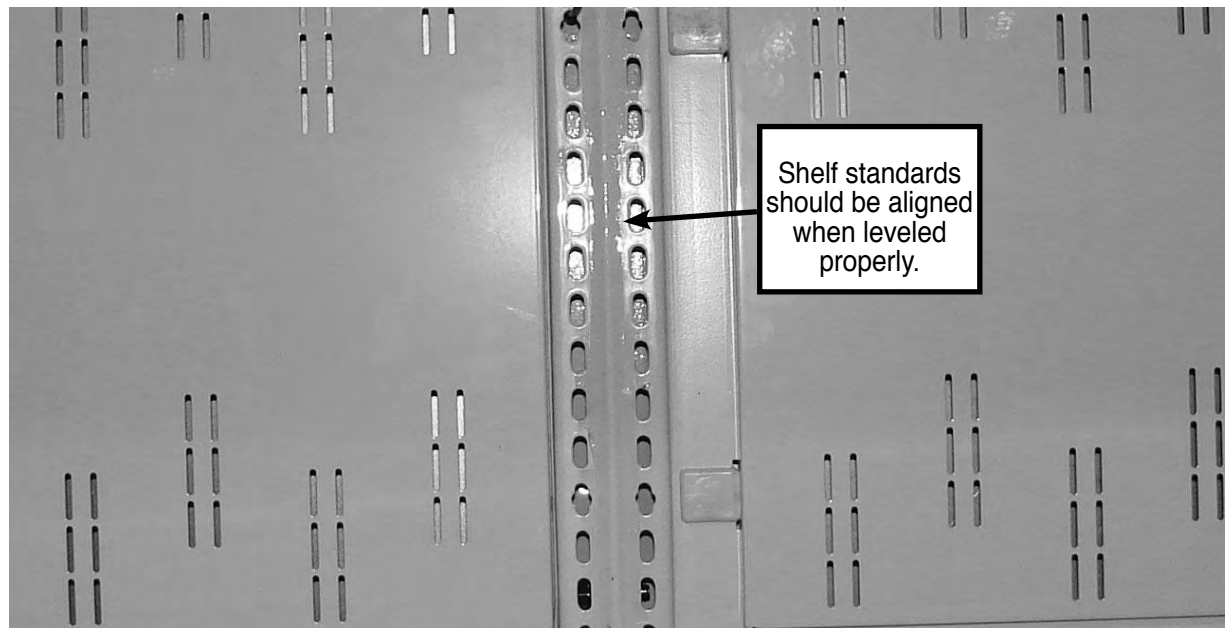

## Waste Outlet (Drip Pipe) Description and Location

These cases are equipped with 1½" PVC (½" for ultra-low cases) waste outlet connection that terminates in the center of the 4' and 6' (the 8' and 12' are split into two halves) refrigerator below the insulated bottom. The water seal trap, elbow, and cap are shipped loose for field installation.

NOTE: Improperly installed drip pipes can seriously affect the operation of this case and result in increased maintenance cost. Listed below are some general rules for drip pipe installation.

- Never use a double water seal.
- Never use a pipe smaller than the size pipe or water seal supplied with the case.
- Always provide as much fall as possible in drip pipe (1" fall for each 4' of drip pipe.)
- Avoid long runs in drip pipe, which make it impossible to provide maximum fall in pipe.
- Provide a drip space between drip pipe and floor drain or sewer connection.

## Case Freezing

Do not allow drip pipe to come in contact with un-insulated suction lines, which will cause the condensation from your case to freeze.

## Drain Strainer

NOTE: Not all Heatcraft cases have drain strainers. This information applies only to the cases equipped with strainers.

The drain strainer is used to keep debris or any foreign objects from entering the PVC drain, which could cause blockage. To install, insert into drain until drain strainer stops. It will not be flush. Strainer will exceed hub by 1". DO NOT flatten drain strainer.

NOTE: 1½" Drain Pipe.



## Electrical Connections—General

**CAUTION:** Failure to properly install electrical wiring and control wiring as per wiring diagram(s), defrost settings, and temperature set-points may result in operational issues such as the following: increased BTUH load, high product temperature, coil icing, product frosting, and external sweating.

### Shelf Light Installation—T8 Shelf Lights

- Make sure plugs are FULLY SEATED before applying power.
- Due to the nature of rapid start ballasts, it is highly recommended that lights are plugged in BEFORE power is applied to cases, and BEFORE cases are at temperature.
- If lights flicker when first started up, cut power to lights, verify plug is fully seated, then make sure power is off for at least 20 seconds before re-applying power.

**CAUTION:** Failure to follow these instructions may result in premature bulb and ballast failure.

**NOTE:** Failure to follow installation instructions may void standard warranty.

### Wiring Diagram—Off Cycle Defrost

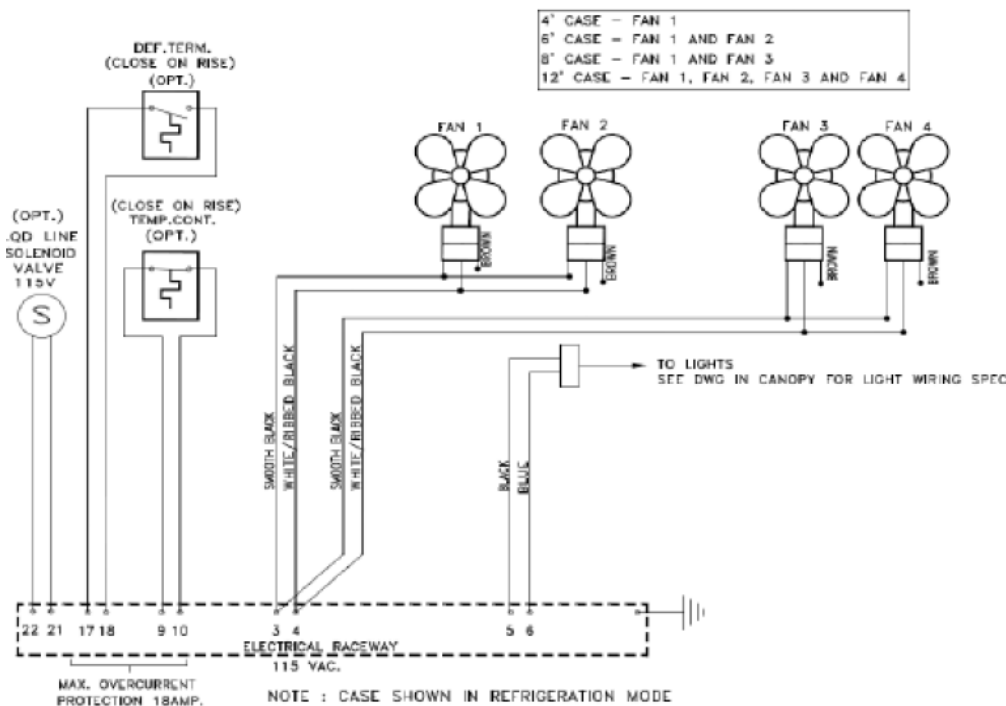

**WARNING!** Ensure the kickplate does not come in contact with the case electrical wiring. Live electrical wiring that comes in contact with the case is a shock hazard that may cause severe injury or death by electrocution.

**WARNING!** Always disconnect the electrical power at the main disconnect when servicing or replacing any electrical component. This includes, but is not limited to, such items as fans, heaters, thermostats and light bulbs. Failure to disconnect the electrical power may result in personal injury or death.

The wires are clearly identified for termination purposes as follows:

| Component                                | Wire Number |
|--|-------------|
| Anti-Sweat Heater                        | 1 and 2     |
| Refrigerator Fan Motors and Drain Heater | 3 and 4     |
| Lighting Circuit                         | 5 and 6     |
| Defrost Heaters                          | 7 and 8     |
| Temperature Control                      | 9 and 10    |
| Dual Temperature                         | 15 and 16   |
| Defrost Termination Control              | 17 and 18   |

# Installation and Operation Manual

## Refrigeration Piping and Dehydration

### Opening a Ferrule Hole

The refrigeration lines are located under the deck pans. A refrigeration outlet is provided in the front right hand end of the cases. All refrigeration lines need to be as close to the drain pan as possible so as not to obstruct the air pattern or block the deck pans.

### Double Valve

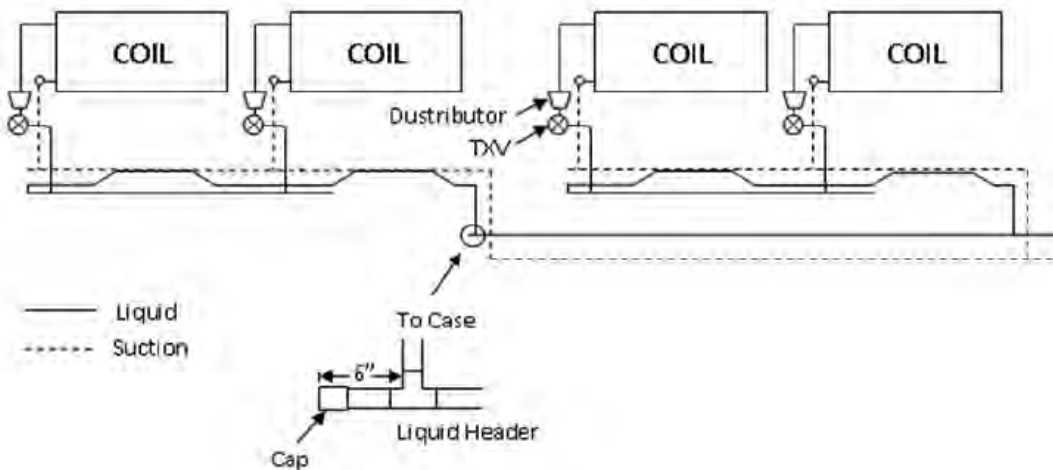

### Single Valve

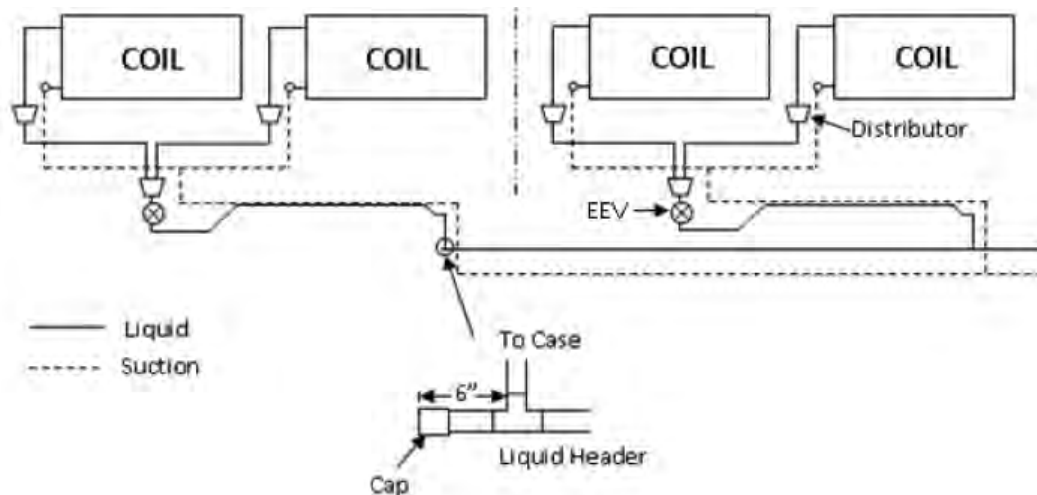

NOTE: All 4 FT and 6 FT cases are single coil and single valve piping. Our standard 8 FT and 12 FT cases have 2 coils and 2 TXV (expansion valves). Custom orders on 8 FT and 12 FT cases that have 1 valve, the valve must be electronic and the case must have a case controller.

## Recommended Piping Instruction

1. Proper size refrigeration lines are essential to good refrigeration performance. Suction lines are more critical than liquid or discharge lines. Oversized suction lines may prevent good oil return to the compressor. Under-sized lines can rob refrigeration capacity and increase operating cost. Consult the technical manual or legend sheet for proper line sizes.
2. Refrigeration lines in cases in line-ups can be reduced. However, the lines should be no smaller than the main trunk lines in at least 1/3 of the cases and no smaller than one size above the case lines to the last case. Reductions should not exceed one line size per case. It is preferred to bring the main trunk lines in at the center of line-up. Liquid lines on systems on hot gas defrost must be increased one line size above the main trunk line for the entire line-up. Individual feed lines should be at the bottom of the liquid header. (See proper liquid line piping diagram.)
3. Do not run refrigeration lines from one system through cases on another system.
4. Use dry nitrogen in lines during brazing to prevent scaling and oxidation.
5. Insulate suction lines from the cases to the compressor with 3/4" wall thickness foam on low temperature cases to provide maximum of 65-degree super heated gas back to the compressor and prevent condensation in exposed areas. Insulate suction lines on medium temperature cases with 1/2" thick insulation in exposed areas to prevent condensate drop-off.
6. Suction and liquid lines should never be taped or soldered together. Adequate heat exchanger is provided in the case. Heatcraft Worldwide Refrigeration recommends use of heat exchanger in all medium and low temperature cases that are not mechanically sub-cooled for proper operation.
7. Refrigeration lines should never be placed in the ground unless they are protected against moisture and electrolysis attack.
8. Always slope suction lines down toward the compressor, 2" each 10'. Do not leave dips in the line that would trap oil.
9. Provide P traps at the bottom of suction line risers, 4' or longer. Use a double P trap for each 20' of risers. P traps should be the same size as the horizontal line. Consult the technical manual or legend sheet for proper size risers.
10. Use long radius ells and avoid 45 degree ells.
11. Provide expansion loops in suction lines on systems on hot gas defrost. An expansion loop is required for each 100' of straight run.
12. Strap and support tubing to prevent excessive line vibration and noise.
13. Brazing of copper to copper should be with a minimum of 10% silver. Copper to brass or copper to steel should be with 45% silver.
14. Do not use bullhead tees in suction lines. An example is where suction gas enters both ends of the tee and exits the center. This can cause a substantial increase in pressure drop in the suction lines.
15. When connecting more than one suction line to a main trunk line, connect each branch with an inverted trap.

## Suction Line

1. Pitch in direction of flow.
2. Suction lines should enter at the top of the branch line.
3. May be reduced by one size at one third of case run load and after the second third. DO NOT reduce below the case suction line size.

# Installation and Operation Manual

## Expansion Valve and Superheat

**CAUTION:** During service of this equipment, precautions should be taken to prevent loss of refrigerant to the atmosphere. Always install the expansion valve stem cap after making valve adjustments.

The expansion valve furnished with your case has been sized for maximum coil efficiency. To adjust superheat, perform the following:

1. Place a thermocouple near the expansion valve bulb. Read the suction line pressure as near coil as possible. If closest is at the condensing unit, estimate suction line loss at 2 PSIG.
2. Convert coil suction pressure to temperature. The difference between coil temperature and the thermocouple temperature is superheat. Use average superheat when expansion valve is hunting.
3. Do not set the superheat until cases have pulled down to operating temperature and never open or close the valve over  $\frac{1}{4}$  turn between adjustments and allow 10 minutes or more between adjustments.
4. Superheat should be set at 6–8°F.
5. After the initial setting, the superheat should be rechecked when product is stocked and at designed
6. temperature.

## Superheat Calculations

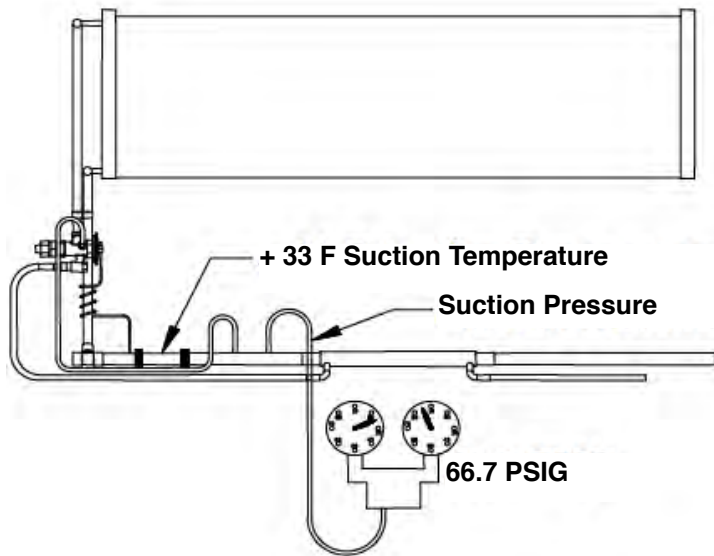

**Example: R404**

**+ 33 F Suction Temperature**

**+ 28 F Suction Pressure Converted to Temperature**

**= +5 F Superheat**

## LED Angle Adjustment Instructions

1. Isolate mains supply.

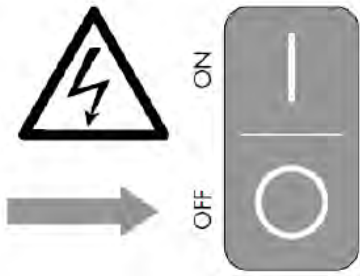

2. Remove luminaire.

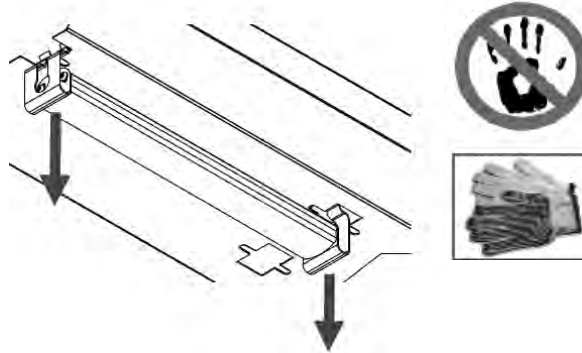

3. Check indicator tab for current angle setting.

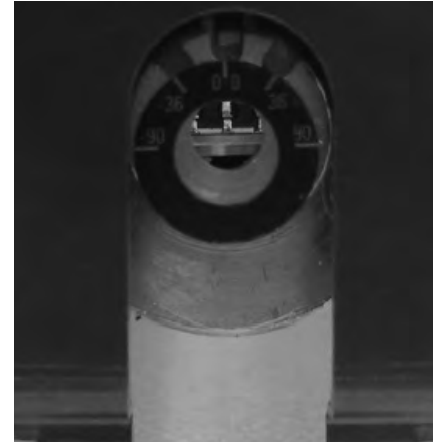

4. Push up on tabs and pull the indicator tab away from the angle dial.

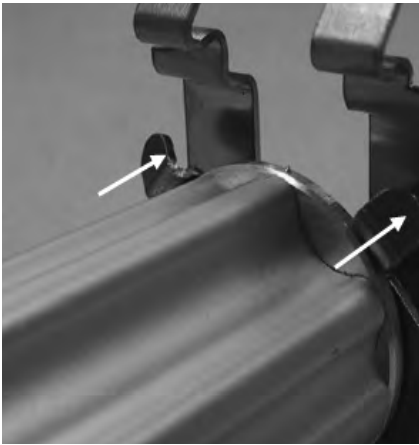

5. Twist cap to desired angle.



6. Press cap back into place.

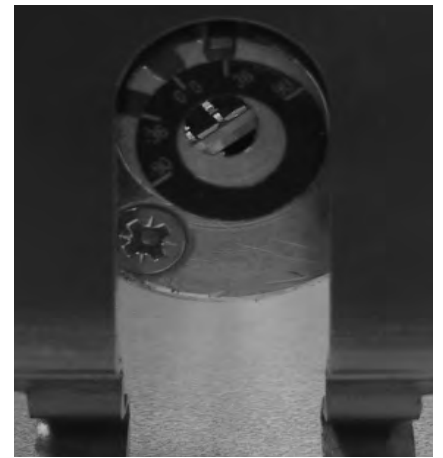

7. Replace luminaire.

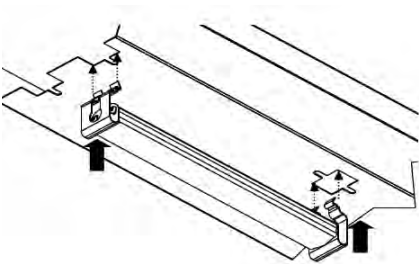

8. Reconnect mains supply.

# Installation and Operation Manual

## ECM Evaporator Fan

### Product Overview

This troubleshooting guide covers the evaporator fan. The fan is supplied as a complete assembly (fan blade, motor mount and power harness) with no replaceable components. An electronically commutated (brush-less) motor powers the fan.

### The following problems are addressed:

- motor is not spinning at the correct speed
- motor is not spinning
- motor sounds noisy

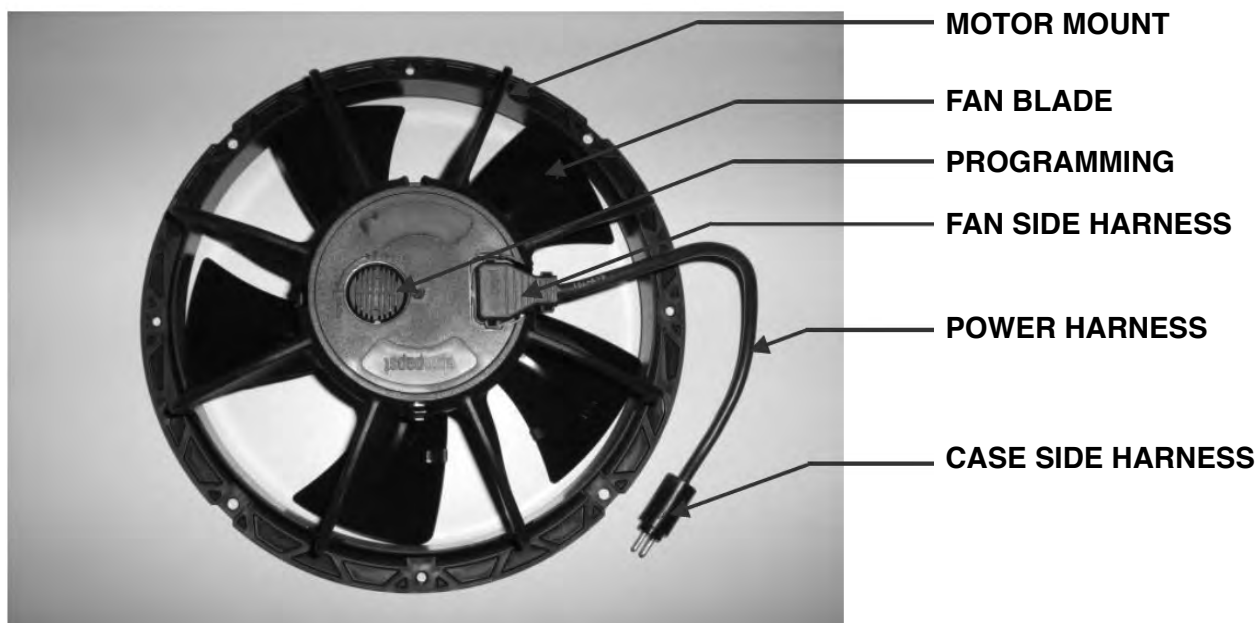

### Procedures—Fan mounted in the case

#### Motor is not spinning at the correct speed

- Disconnect fan power. Use the handheld speed programmer P/N HX0C-003-000-01 and the instructions in the accompanying operating manual to confirm that the fan speed setting is correct for the case model. If the setting is incorrect, reprogram the fan as needed, disconnect the programmer and reconnect fan power. If the setting is correct, continue with the troubleshooting.

#### Motor is not spinning

- Perform a hard reset of the electronics by removing power to the fan for at least 10 seconds.
- Check that the fan blades are completely free of obstruction by manually spinning the fan blade.
- If any obstruction is found, remove it and inspect the fan blades for damage.
- Replace any fan with bent or gouged blades. Small nicks in the blades are acceptable.
- Check that the correct power is being applied at the case side of the fan harness and that the harness is firmly connected to the power line.
- Reapply fan power and check if the problem has been resolved.

**NOTE:** If the above actions do not solve the problem, disconnect power to the fan and remove the fan from the case along with its harness.

## Procedures—Fan removed from the case

1. Disconnect the fan plug from the case wire harness and inspect the pins. If they appear bent, straighten them out and reconnect the plug. If pins are broken, replace the power harness.
2. Remove the fan side harness plug from the back of the fan. This is generally best accomplished by placing a thumb under the plug and applying steady pressure outwards from the fan.
3. Check for liquid in the slot where the harness plugs into the fan. If any liquid is present, check that the seal around the perimeter of the slot is completely intact. Replace any fan with a damaged seal. If the seal is good, completely dry out the slot and the harness pins before proceeding further.
4. Check the resistivity across the L1 & N fan side male pins with the common lead from the ohmmeter on the N pin. Check the resistivity across the speed selection and L1 pins with the common lead on the L1 pin. Both measurements should have a value of M $\Omega$ 's (typically 2-3M $\Omega$ ). If either reading is zero or infinity, replace the fan.
5. If the resistivity measurements are good, reconnect the power on the case side of the fan harness and check

2—FAN HARNESS PLUG



4—RESISTIVITY



SPEED SELECTION

L1 (LINE)

N (NEUTRAL)

SEAL

- that the correct voltage is being applied at the fan side harness pins.
6. If a problem is found with the voltage at the fan side of the harness, perform a continuity test on each leg of the harness. Replace the fan if the harness is found to be bad.
  7. If the continuity test is good, check the fan side harness connections for any damage or corrosion to the female pins in the harness or the male pins in the fan. Replace the fan if any damage or corrosion is seen.

NOTE: If the above checks / changes do not fix the motor issues, the motor should be replaced.

NOTE: Any time the fan side harness connector is plugged back into the fan, be sure to press it all the way down in order to make a good seal.

# Installation and Operation Manual

## Operation

Merchandise should not be placed in the fixture until all controls have been adjusted and the case is at the proper temperature. **AT NO TIME SHOULD THE CASE BE STOCKED BEYOND THE LOAD LINE OR OVER THE FRONT EDGE OF THE ADJUSTABLE SHELVES.**

**CAUTION:** Air discharge and return flues must remain open and free of debris or obstruction at all times to provide proper refrigeration and air current performance.

**CAUTION:** Do not allow any product, signs, debris, etc., to block these grilles.

**CAUTION:** Do not use any non-approved shelving, display racks, or any accessory that could hamper air current performance.

**WARNING!** Do not walk on top of the cases! This could result in damage to the case and serious personal injury could occur. These cases are not designed to support excessive external weight. Do not use top of cases for storage.

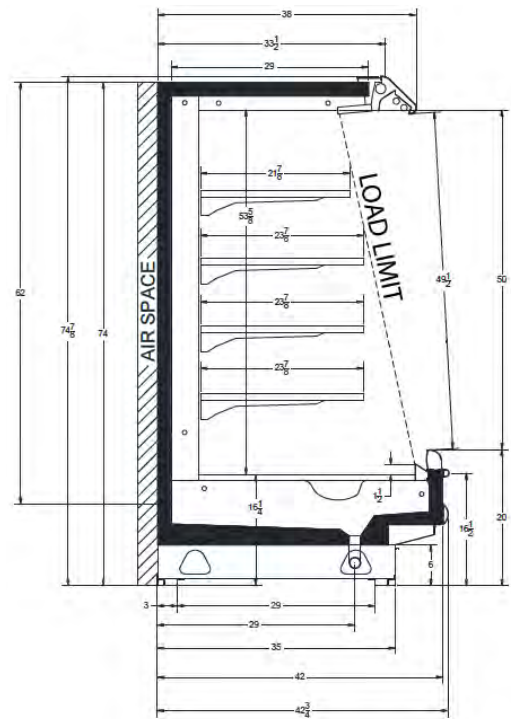

1. Off-Cycle Defrost is standard on these models. The fans run continuously and defrost termination is by termination Klixon.
2. Single Condensing Case Systems – A thermostat should be used to control case temperatures. The thermostat bulb should be mounted in the discharge air (see case data if your case is a single condensing case system).

**NOTE:** Where termination temperatures are given, mechanical defrost termination is required.

## Cleaning

As a general rule, always use mild soap and water to wipe the case down, including the sliding doors at the back of the case. Special precautions must be taken when cleaning some components of the case.

Exterior surfaces should be cleaned with warm water and mild soap to protect and maintain the finish. Do not use cleaners containing abrasive materials or ammonia, which will scratch or dull the finish. The waste outlet should be flushed with water following each cleaning.

Interior surfaces may be cleaned with most mild soap formulas, ammonia based cleaners, and sanitizing solutions with no harm to the surface.

**WARNING!** Always shut power off during the cleaning process. Cleaning the case with electrical power applied is a shock hazard that may cause serious injury or death.

**WARNING!** DO NOT USE HOT WATER ON COLD GLASS SURFACES. This could cause the glass to shatter and could result in personal injury. Glass fronts and ends should be warm before applying hot water.



# STRATUS Multi-Deck Display Case

## CAUTION—The following could damage the case:

- Use of cleaning products containing chlorine, chloride ion, the words Bleach, is not recommended for unpainted stainless steel surfaces as it may cause rust to form. The operational warranty of the equipment will be voided if these products cause rust to form on the stainless steel parts or any other parts of the equipment.
- Do not use solvent, oil, or acidic-based cleaners on any interior surfaces as the surface may become damaged.
- Do not use abrasive cleaners and scouring pads, as these will mar the finish.
- Never introduce water into the case faster than the waste outlet can release it.
- Do not use steam or high pressure systems to clean the case, as seals may be broken which will cause the case to leak.

## Shelves

Do not use a hose or submerge shelves in water. When cleaning lighted shelves wipe down the shelves with a wet sponge or cloth so that water does not enter the light rails.

## Mirrors

Mirrors are sheets of clear glass that have a very thin reflective coating applied to one side. These coatings are susceptible to deterioration if certain cleaning solutions and even water are allowed to come in contact with them. Every precaution should be made to keep liquids away from the coated side of the mirrors. If liquids are allowed to flow along the face side of the mirror to its edge, the liquid can seep between the coating and the glass, causing serious damage.

## To help prolong the life of the mirrors:

- Use only mild cleaning solutions (Windex, Solox, or a weak solution of vinegar and water).
- Do NOT spray liquids on mirrors. Dampen the cleaning cloth, and then use the cloth to wipe the mirror.
- Wipe water from the mirrors immediately to prevent difficult to remove water spots and also to prevent the water from reaching the mirrors edge.
- Never use dirty cloths, scrapers, or any other abrasive materials for cleaning.

## Honeycomb Assembly

The honeycomb should be cleaned every 6–8 months, depending on store conditions. The honeycomb may be cleaned with a vacuum cleaner or removed to be washed with soap and water. The honeycomb must be completely dry before returning it to the case. Note the position and angle of the honeycomb when removing from the case. Honeycomb must be replaced at the same angle.

SCREWS

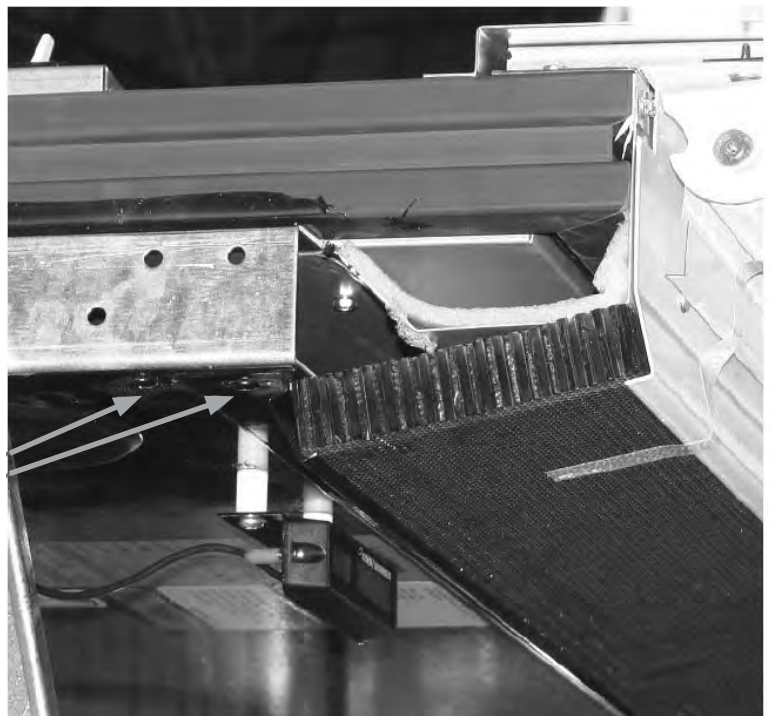

# Installation and Operation Manual

## Parts List

| Description   | Part No. | Quantity |      |      |       |
|---------------|----------|----------|------|------|-------|
|               |          | 4 FT     | 6 FT | 8 FT | 12 FT |
| Fan Motor ECM | 09A10114 | 1        | 2    | 2    | 4     |
| Deck Pan PTD  | 54N18237 | 2        | 3    | 4    | 6     |
| Deck Pan BRT  | 55M16029 | 2        | 3    | 4    | 6     |

| Description         | Part No. |          |          |          |
|---------------------|----------|----------|----------|----------|
|                     | 4 FT     | 6 FT     | 8 FT     | 12 FT    |
| External Drain Trap | 96H46371 | 96H46371 | 96H46370 | 96H46369 |

NOTE: Standard parts are provided in the parts lists. Cases may be equipped with specialty parts that were incorporated into the case(s) at the time they were manufactured. It is important to have the case serial number when contacting Heatcraft Worldwide Refrigeration for replacement parts.

## Warranty—Rev. January 2015

### Standard Warranty:

Seller warrants to its direct purchasers that Products, including Service Parts, shall be of a merchantable quality, free of defects in material or workmanship, under normal use and service for a period of one (1) year from date of original equipment start-up, or eighteen (18) months from date of shipment by Seller, whichever first occurs. This warranty runs to only the original purchaser of equipment or part. Any Products covered by this warranty found to Seller's satisfaction to be defective upon examination at Seller's factory will at Seller's option, be repaired or replaced and returned to Buyer via lowest common carrier Ex-Works Seller's dock. This is buyer's sole and exclusive remedy and, except as provided in the next sentence, seller's sole and exclusive liability in connection with the warranty. Or Seller may, at its sole option, grant Buyer a credit for the purchase price of the defective Product. Buyer must prepay all costs for transportation of Products to Seller's factory.

Seller shall have no liability for expenses incurred for repairs made by Buyer except by prior, written authorization. Any claim under this warranty shall be made to Seller in writing within the warranty period specified above – otherwise such claim shall be deemed waived. Seller shall have no warranty obligation whatsoever if its products have been subjected to alteration, misuse, negligence, free chemicals in system, corrosive atmosphere, accident, or if operation is contrary to Seller's or manufacturer's recommendations, or if the serial number has been altered, defaced, or removed.

THIS WARRANTY IS IN LIEU OF ALL OTHER WARRANTIES, EXPRESSED, IMPLIED OR STATUTORY, INCLUDING, BUT NOT LIMITED TO ANY WARRANTY OF MERCHANTABILITY OR FITNESS, AND ALL OTHER OBLIGATIONS OR LIABILITIES OF SELLER ARE HEREBY DISCLAIMED.

### Additional Warranties:

The Standard Warranty specified above applies to all Products and Service Parts unless modified by the following:

#### THERMO-FLEX™ OR FLOATING TUBE™ DESIGN COIL

Seller warrants the Thermo-Flex/Floating Tube Design Coil of the "BM", "BH", "CM", "CH", "HM", "HH", "MM", "ML" or "LH" series of Unit Coolers; coil section of the "BLV", "BDVS", "BBV", "JLD", "JDDS", "JBD", "BDT", "BDN", "BDS", "BDB", "BZT", "BZN", "BZS", "BZB", "CDD", "CDDS", "CDT", "CDN", "CDS", "CZT", "CZN", "CZS", "HDD", "HDDS", "HDT", "HDN", "HDS", "HZT", "HZN", "HZS", "LDV", "LDVS", "LDD", "LDDS", "LDT", "LDN", "LDS", "LZT", "LZN", "LZS" condensing units; and coil section of the "BN", "CN", "HN" or "LN" models of Air-cooled Condensers for a period of five (5) years from shipping date, in the event of any documented and verified (by Seller's representative) leaks in the coil tubes containing refrigerant at the point of and caused by tube contact with the end or center coil support sheets.

# STRATUS Multi-Deck Display Case

---

Seller will also reimburse the replacement cost of lost refrigerant for a period of five years from the date of shipment from leaks specifically caused by the reasons stated above. The replacement cost will be limited to one full system charge. The warranty specifically excludes leaks at header and weld joints, split tubes or leaks caused by failure to operate the product in accordance with published guidelines for operation and installation of equipment. The cost of replacement refrigerant will be limited to Seller's indexed nationwide average of refrigerant cost per pound. The warranty excludes any fines/fees related to refrigerant leaks.

## Air-cooled CONDENSERS "BN", "CN", "HN", "LN" or "NRG" Models"

Seller warrants Air-cooled Condensers "BN", "CN", "HN", "LN" or "NRG" Models" for a period of two (2) years from date of original installation, or 30 months from the date of shipment by Seller, whichever first occurs.

## Optional EC Condenser Fan Motors EC Motors

Seven (7) Blade motor assemblies – for a period of four (4) years from date of original installation, or fifty-four (54) months from date of shipment by Seller, whichever first occurs.

Five (5) Blade motor assemblies – for a period of three (3) years from date of original installation, or forty-two (42) months from date of shipment by Seller, whichever first occurs.

## Unit Cooler EC Fan Motors

Seller warrants EC Motors (made by McMillan) for a period of two (2) years from date of original installation, or thirty (30) months from date of shipment by Seller, whichever first occurs.

## Beacon II™ CONTROL SYSTEMS

Seller warrants the Beacon II™ Control System for a period of three (3) years from the date of original installation, or forty-two (42) months from the date of shipment by Seller, whichever first occurs.

## PRO3 PACKAGED REFRIGERATION SYSTEM:

Seller warrants the PRO3 Packaged Refrigeration System for a period of two (2) years from date of original installation, or thirty (30) months from date of shipment by Seller, whichever first occurs.

## HYPERCORE™ Microchannel Coil

Seller warrants the Hypercore™ Microchannel Condenser Coil for a period of two (2) years from date of original installation, or thirty (30) months from date of shipment by Seller, whichever first occurs.

## SMART DEFROST KIT™

Seller warrants the Smart Defrost Kit™ for a period of two (2) years from date of original installation, or thirty (30) months from date of shipment by Seller, whichever first occurs.

## MOTOR COMPRESSORS:

Motor compressor replacements or exchanges shall be made through the nearest authorized wholesaler of the motor compressor manufacturer (not at Seller's factory) and no freight shall be allowed for transportation of the motor compressor to and from the wholesaler. The replacement motor compressor shall be identical to the model of the motor compressor being replaced. Additional charges which may be incurred throughout the substitution of other than identical replacements are not covered by this warranty. An optional, non-assignable, three (3) or four (4) year extended compressor warranty may be purchased for extra cost within the boundaries of the United States of America, its territories and possessions, and Canada. With this extended compressor warranty, replacements are administered by an authorized compressor distributor only. Replacements within the time period of the standard Warranty (as modified in some instances as stated above) are available through the distributor; for the remaining years, the purchaser must submit a proof-of-purchase of a compressor and supply it to Heatcraft Warranty Claims for reimbursement.

# Installation and Operation Manual

---

## THIS WARRANTY SHALL NOT APPLY:

1. Glass is not guaranteed against breakage. If this refrigerator is equipped with a glazing assembly carrying the manufacturer's brand name (Thermopane, Twindow, etc.), the manufacturer's glazing warranty in effect at the time of this shipment is extended to that assembly.
2. BULBS: Light bulbs, fluorescent lamp tubes and LEDs are not covered by any warranty for length of life or for any type of breakage.
3. To the condensing unit used with refrigerated equipment unless same was sold and shipped by Seller
4. When this equipment or any part thereof is damaged by accident, fire, flood, act of God, alteration, abuse, misuse, tampering, when the original model and serial number plate has been altered, defaced, or removed or used other than the recommended application by Seller.
5. When this equipment or any part thereof is subject to operation on low, high or improper voltages. Low and high voltage is defined as more than a 5% drop below or 10% higher than name plate voltage ratings. NOTE: Proper field supply voltage to the equipment is the responsibility of the owner (end user).
6. To damage caused by overloading shelves or wire racks beyond the specified weight limits. The maximum weight limit for Seller's standard shelves and wire racks is 30lbs per square foot.
7. When this equipment or any part thereof is damaged, or when operation is impaired, due to failure to follow installation manual. NOTE: Proper installation is the responsibility of the installer, owner (end user).
8. Operational issues caused by ambient environmental conditions outside of the specified limits. Seller's indoor equipment is specified to operate in a conditioned ambient environment not to exceed 75 degrees Fahrenheit or 55% relative humidity. NOTE: Providing specified ambient environmental conditions are the responsibility of the owner (end user).
9. To equipment with final destinations unknown to seller as indicated on the original sales order.
10. To labor cost for repair or replacement of parts.
11. To special or expedited freight or shipping charges or to customs duties to any country.
12. If the Warranty holder fails to comply with all the provisions, terms and conditions of this Warranty.

Parts replaced under this Warranty are warranted only through the remainder of the original Warranty.

Extended Service Agreements are provided by a third party not affiliated with Seller. The services provided by the third party are subject to the terms and conditions of the Extended Service Agreements and Seller is not responsible for those services or the third party's performance of its obligations.

IT IS EXPRESSLY UNDERSTOOD AND AGREED THAT SELLER SHALL NOT BE LIABLE TO BUYER, OR ANY CUSTOMER OF BUYER, FOR INDIRECT, SPECIAL, INCIDENTAL, CONSEQUENTIAL OR PUNITIVE DAMAGES, INCLUDING LOSS OF PROFITS, ADDITIONAL LABOR COSTS, LOSS OF REFRIGERANTS OR FOOD PRODUCT, OR ANY INJURY TO PERSON OR PROPERTY CAUSED BY DEFECTIVE MATERIAL OR PARTS OR FOR ANY DELAY OR MISPERFORMANCE IN THE PERFORMANCE DUE TO CAUSES BEYOND ITS CONTROL OR FOR ANY EXPENSES INCURRED BY REASON OF THE USE OR MISUSE BY BUYER OR THIRD PARTIES OF THE PRODUCTS. SELLER'S MAXIMUM LIABILITY FOR DIRECT DAMAGES IS LIMITED TO THE AMOUNT PAID BY THE BUYER FOR THE PARTICULAR ITEM OF EQUIPMENT OR PART INVOLVED.

NOTE: IN THE CONSTANT EFFORT TO IMPROVE OUR PRODUCTS, WE RESERVE THE RIGHT TO CHANGE AT ANY TIME SPECIFICATIONS, DESIGN, OR PRICES WITHOUT INCURRING OBLIGATION.



# KYSOR WARREN

5201 Transport Blvd.  
Columbus, GA 31907  
P: 800.866.5596  
F: 706.568.8990



[www.kysorwarren.com](http://www.kysorwarren.com)