











DX8UD - STRATUS

MULTI-DECK SPECIFICATION SHEET



General Case Data	Case Length (ft)			APPLICATIONS
	4'	8'	12'	
Total Display Area (ft ²)	22.60	45.20	67.85	         
Cubic Capacity (ft ³)	50.97	101.94	153.04	
Max Shelf Depth (in) [Top/Bottom]	22/22	22/22	22/22	
Weight (lb)	-	-	-	
Refrigeration Data (General)				
Discharge Air Velocity (fpm)	185	185	185	
Fan Speed (rpm)	1400	1400	1400	
Discharge Air Temp (°F)	34	34	34	
Conventional Thermal Load, Single (Btuh) unlighted	746	1489	2234	
Parallel Thermal Load, Single (Btuh) unlighted	676	1349	2024	
Refrigeration Data (HFC)				
Evaporator Temperature (°F)	28	28	28	
Superheat Setpoint (°F)	6 - 8	6 - 8	6 - 8	
Estimated Refrigerant Charge (lbs)	1.266	2.532	3.789	
Refrigeration Data (Glycol)				
Supply Temperature (°F)	20	20	20	
Flow (GPM)	QTE	QTE	QTE	
Fluid %	35	35	35	
Pressure Drop (PSID)	QTE	QTE	QTE	
Electrical Data (Amps/Watts)				
115V/60Hz, 1 Phase				
Fans	0.17	0.33	0.60	
Defrost Data (off Cycle)				
Defrosts per Day	Failsafe Duration (min) ¹	Termination Temp (°F)	Drip Time (min)	
3	45	47	0	

¹ At ASHRAE conditions. For conditions above 75°F, 55% RH, increase defrost time by 15 min. Type I refrigerator, intended for use in an area where the environmental conditions are controlled and maintained that conditions do not exceed 75°F and 55% relative humidity. Heatcraft Worldwide Refrigeration, whose policy is one of continuous improvement, reserves the right to change at any time specifications, designs, or prices without incurring obligation. DOE 2017 Compliant

The above case model has case lengths that are UL and NSF approved.

DX8UD - STRATUS

MULTI-DECK SPECIFICATION SHEET

DX8UD CROSS VIEW

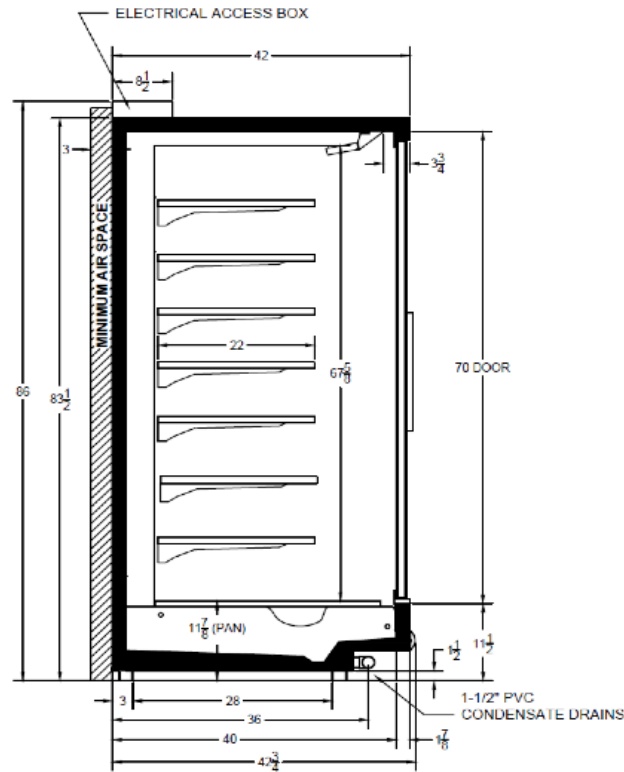

Add 3" thickness for a pair of ends.

DX8UD PLAN VIEW

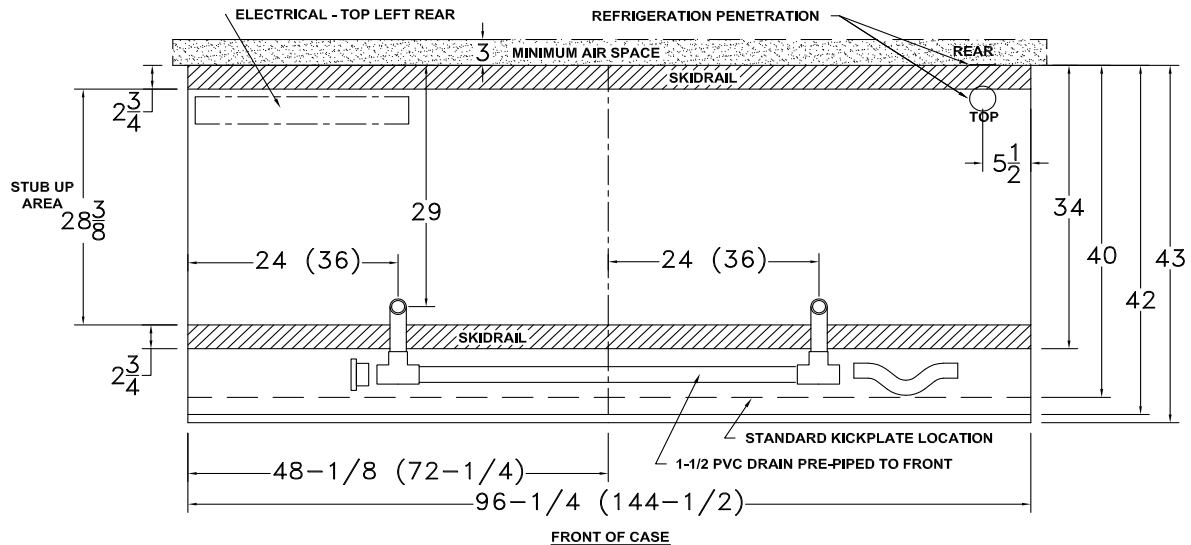

5201 Transport Blvd
Columbus, GA 31907
P: 800.866.5596 • F: 706.568.8990



www.kysorwarren.com

