

**HFC**

MANUAL

# PARALLEL COMPRESSION REFRIGERATION

## HFC REFRIGERANTS

---

*INSTALLATION  
AND OPERATION*  
**MANUAL**



**KYSOR WARREN**  
eptarefrigeration

# 1

## HFC SYSTEMS

1.1. Introduction	04
1.2. System Overview	04
1.3. System Operation Basics	06
1.4. Subsystems	07
1.5. Options	11

# 5

## SYSTEM OPERATION

5.1. System Power	30
5.2. Initial Charging	30
5.3. Starting Compressors	31
5.4. Final Charging	31
5.5. Controls and Programming	32
5.6. Evaporator Operation	33
5.7. Defrost Operation	33

# 2

## SAFETY INFORMATION

2.1. Safety	16
2.2. Warning Signage	16
2.3. Personal Protection Gear	16

# 6

## MAINTENANCE & TROUBLESHOOTING

6.1. General Maintenance Procedures	36
6.2. Troubleshooting	37

# 3

## INSPECTION AND PLACEMENT OF MATERIAL

3.1. Inspection of Materials	18
3.2. Rating Plate	18
3.3. Lifting Instructions	19
3.4. Placement of Equipment	19

# A

## APPENDICES

A. Standard Warranty Manual Disclaimer	40
B. Forms and Reports	43

# 4

## SYSTEM INSTALLATION

4.1. General	23
4.2. Responsibilities	23
4.3. Field Piping	23
4.4. Testing and Evacuation	26
4.5. Insulation	27
4.6. Electrical	28

**HFC**  
MANUAL

1

*HFC*  
**SYSTEMS**



**KYSOR WARREN**  
eptarefrigeration

## HFC SYSTEMS

### 1.1 INTRODUCTION

This manual provides an introduction to Kysor/Warren's (KW) portfolio of HFC compressor refrigeration systems. The intended audience are contractors and other personnel involved in the installation and operation of these systems. It is NOT an instruction manual nor should it be considered definitive. Plans developed by Kysor/Warren, the client's procedures and instructions, industrial standards, and other instructions must be used to properly install and operate this system.

### 1.2 SYSTEM OVERVIEW

Kysor/Warren (KW) provides a wide range of advanced systems designed for the specific needs of the customer. Every product produced by KW is therefore unique. Table 1-1 summarizes the current KW HFC product portfolio. For specific questions, contact the KW Application Engineering department to ensure the best model is selected as the basis for the design.























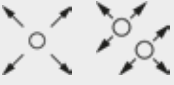















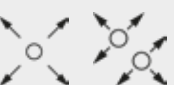

Picture	Model	Name / Description	Application	Design	Compressor	
					Type	Qty
	Defender	Modular Outdoor System				2-6 3 per stack
	DSP	Scroll Pack				1-3
	DSS	Distributed Scroll System				2-6 3 per stack
	CSS	Compact Scroll System				2-9
	NH2	Narrow Horizontal				2-12  2-9
	DVR	Double Stack Parallel Pack				2-16  2-14
	NHS	Narrow Horizontal slimline				2-12  2-9
	OHW	Outdoor Horizontal (Wide or Narrow)				2-12  2-14
	OHD OHS	Outdoor horizontal (Double or single Wide)				OHS 6 OHD 7  OHS 4 OHD 5
	WEH	Compact Mechanical Enclosures			To Customer Specifications	

Table 1-1. KW HFC Product Portfolio.

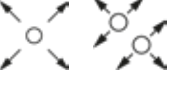
 Centralized    
  Distributed    
  Indoor    
  Outdoor    
  Scroll    
  Semi Hermetic

Table 1-1. KW product portfolio

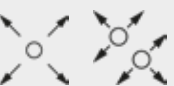
A **centralized system** (Figure 1-1) however, requires extensive facility-wide piping, with at least two pipes (liquid supply, vapor return required). For a hot gas defrost system, three or four additional pipes may be needed

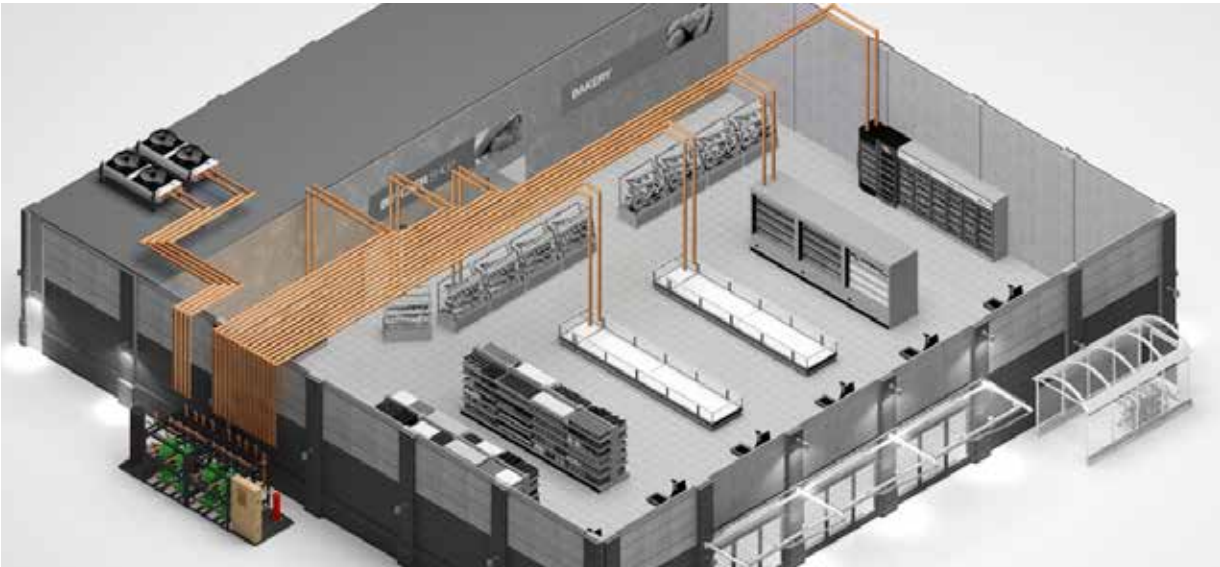

Figure 1-1. Example of a Centralized Refrigeration System

A **distributed refrigeration system** (Figure 1-2), usually on the roof, provides multiple racks placed close to specific loads (cases/evaporators), having a main liquid supply can feed multiple line-ups inside the store. The same way happens with suction return where multiple line-ups merge into main return line to the system.



Figure 1-2. Example of a distributed Refrigeration System

Categories	Centralized	Distributed
Amount of Refrigerant Charge	+	-
Equipment Maintenance	-	+
Piping and Pipe Maintenance	+	-
Space Requirement	+	-
Initial Costs	-	++
Cost Over Time	++	-

Table 1-2 shows some of the advantages and disadvantages for the centralized and distributed systems.

### 1.3 SYSTEM OPERATION BASICS

Figure 1-3 shows the cycle for a basic HFC refrigeration system. In the background is the pressure - enthalpy (p-h) chart for a HFC refrigerant. The pink indicates the high (pressure) side and the blue the low (pressure) side. The numbers on the diagram relate to the refrigerant state explained below.

- **Point 1 → Point 2:** The refrigerant comes into the compressor as a low-pressure vapor and low temperature, it is compressed and then moves out of the compressor as a high-pressure vapor at a higher temperature.
- **Point 2 → Point 3:** The gas then flows to the condenser. Here the vapor changes phase to a liquid, and gives off its heat to the outside air.
- **Point 3 → Point 4:** The liquid then moves to the expansion valve under high pressure. This valve expands the fluid, and lowers its pressure and temperature as it leaves the expansion valve.
- **Point 4 → Point 1:** The low-pressure liquid then moves to the evaporator, where heat from the inside air of the cases and walk-ins is absorbed and changes the refrigerant from a liquid to vapor.

As a low-pressure vapor, the refrigerant moves to the compressor where the entire cycle is repeated.

The range of working pressures and design pressures for the system are shown in Table 1-3.

**NOTE**

The diagram can also be divided based on the refrigerant pressure: a high side indicate high pressure and the low side indicates low pressure.

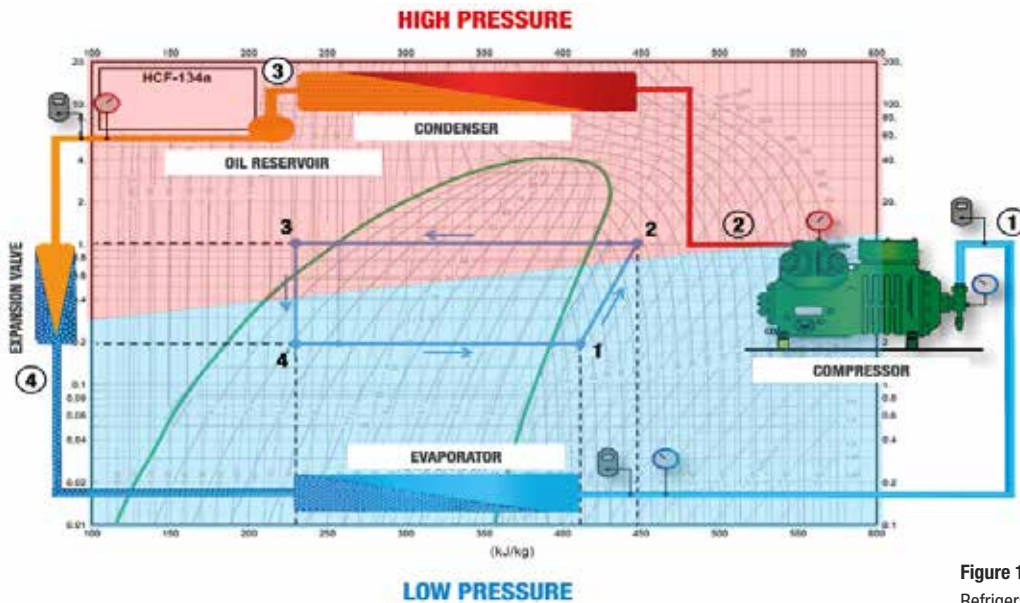

Figure 1-3. Basic Refrigeration Cycle

Line	Description	Working Pressure	Components	Design Pressure
— (light blue)	Low side	6 to 22.6 psig	LT Cases, LT Suction Piping	450 psig
— (medium blue)		36 to 54 psig	MT Cases, MT Suction Piping	
— (red)	High side	127 to 325 psig	Liquid Supply Piping, Discharge Piping, Condenser	

Table 1-3. Range of Working and Design Pressures Shown in Figure 1-3

## 1.4. SUBSYSTEMS

For this manual, subsystems consist of the following: Oil System, Discharge, Liquid Supply, Suction Accumulator and Piping Arrangement.

### 1.4.1 OIL SYSTEM

Oil is essential for the reliability of the compressors in a refrigeration system. As compressors pump refrigerant they also pump a small amount of oil with the refrigerant. The volume of oil in refrigerant lines and heat exchangers displaces refrigerant volume, and reduces the efficiency of the system. To avoid trapping oil in other parts of the system and depleting the oil level in the compressors, it is extremely important to recover and properly return it to the compressor crankcase.

#### COALESCING OIL SEPARATOR

Coalescing separators are capable, with proper design, of removing 95% to 99% of the oil component of mass flow. They use a filter media of highly pure glass fibers, capable of exciting even the smallest oil molecules. This material forces the molecules to collide and form larger droplets, which in turn are routed by gravity through a drain layer.

Coalescing type separators maintain the same level of effectiveness regardless of system velocities and loads. This is increasingly important as more stores employ refrigeration load shifting/matching to reduce energy consumption.



Figure 1-4. Coalescing oil separator

#### CENTRIFUGAL OIL SEPARATORS RESERVOIRS

Designed to remove large quantities of oil in a wide range of operating capacities. The oil separator portion is divided from the reservoir by an internal baffle, which protects the oil in the reservoir from the turbulent action of the oil separator



Figure 1-5. Centrifugal oil separators reservoirs

#### OIL LEVEL CONTROL

Oil must be present to lubricate the compressor. However, oil becomes a detriment to system performance if present in large quantities in the evaporator. The purpose of the oil level control is to regulate the flow of oil to the compressor crankcase and maintain a minimum oil level as specified by the compressor manufacturer for a given application.



Figure 1-6. Oil level control

#### ELECTRONIC OIL LEVEL CONTROL

Monitors the amount of oil in the crankcase. Sends a signal when oil level is too low.



Figure 1-7. Compressor crankcase oil level protective control

### 1.4.2 – DISCHARGE

#### DISCHARGE PRESSURE DIFFERENTIAL VALVE

Pressure regulators are of three primary types: Inlet, outlet, and differential regulator versions.

- Inlet pressure regulators open on a rise in inlet pressure above the valves set point, and close when the inlet pressure drops below the valve's set point.
- Outlet pressure regulators maintain a constant outlet or downstream pressure. Outlet regulators open when outlet pressure falls below the valves set point and close when the outlet pressure is above it's set point.
- Differential pressure regulators open when the pressure differential across the regulator is greater than the valves set point. conversely, they will close when the pressure difference across the valve is below the valve's set point.



Figure 1-8. Discharge pressure differential valve

### HEAT RECLAIM 3-WAY VALVE / SPLIT CONDENSER VALVE

The Heat Reclaim Valve has a pilot operated design that shifts the refrigerant flow to either the normal condenser or the reclaim condenser based on the heating requirements of the application.

The Split Condenser Valve is a simple modification of the standard heat reclaim valve. The upper seat and port of the split condenser valve opens and closes. The lower port is always open. During the normal full condenser mode, the refrigerant flow is split evenly between the two halves of the condenser.

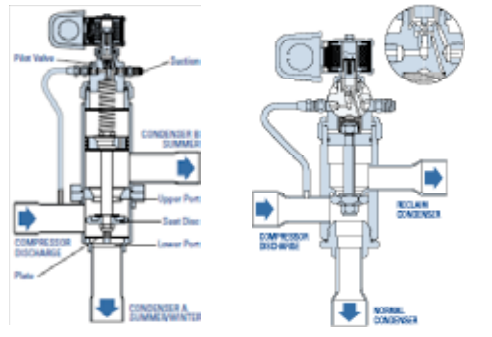

Figure 1-9. Heat reclaim 3-way valve split condenser valve

## 1.4.3 – LIQUID SUPPLY

### Air Cooled Condenser

Air cooled condensers provide an economical and relatively simple method to release heat from the refrigerant. They reject heat to the outdoors and are simple to install (see section 3 for information on the proper positioning of outside condensers). A great feature of the air cooled condenser is they are very easy to clean.



Figure 1-10. Air cooled condenser

### CONDENSER RETURNING VALVE

Pressure regulators are of by three primary types: Inlet, outlet, and differential regulator versions.

The valve is either in a wide open (or bypassed) position with it's solenoid energized to facilitate a minimum pressure drop through the valve when no refrigeration circuits are calling for de-frost. In this mode, the valve essentially is acting as a low pressure drop solenoid in an opened position.



Figure 1-11. Condenser returning valve

### RECEIVER

Refrigeration systems exposed to varying heat loads, or systems utilizing a condenser flooding valve to maintain a minimum head pressure during low ambient temperatures, needs a receiver to store excess refrigerant.

Liquid receivers are installed in the liquid line as close as possible to the outlet of the condenser. The piping between the condenser and the receiver should be arranged to allow free drainage. The piping should also not cause excessive friction pressure loss or gas binding and must have adequately sized valves and connection fittings.

The location of the receiver should not cause excessive heat to be added to the refrigerant, such as from direct solar radiation when located outdoors or near building heating equipment when installed indoors. However, if the receiver is installed outdoors and the system is required to operate during low ambient temperatures, it may be necessary to install trace heaters to maintain adequate pressure in the receiver in order to avoid system problems at startup. A receiver may also have some type of relief valve installed, such as a fusible plug, ruptured disc, or a pressure relief valve.



Figure 1-12. Receiver



### LIQUID RECEIVER PRESSURE VALVE

This valve is normally used in cases where head pressure control is being performed, it will act when the receiver pressure drops below to a specified set-point and will close when the pressure comes back above or to the predetermine set point, to keep the differential pressure for the liquid going into the expansion valves.



Figure 1-13. Liquid receiver pressure valve

### SUBCOOLING (PLATE HEAT EXCHANGER)

Some sub-cooling is necessary to ensure that no gas is formed in the liquid line between the condenser and the subsequent component. Heat exchangers facilitate the efficient transfer of heat. A good heat exchanger is able to transfer energy (heat) from the hot side to the cold side with small thermal losses and high efficiency.

### ELECTRIC EVAORATOR PRESSURE REGULATORS (EPR)

Electronically controlled step motor valves, designed to contribute minimal pressure drop to the system

### ELECTRIC EXPANSION VALVES

Electronically Operated Step Motor flow control valves, intended for the precise control of liquid refrigerant flow. Synchronized signals to the motor provide discrete angular movement, which translate into precise linear positioning of the valve piston.



Figure 1-14. Subcooling assembly

## 1.4.4 – SUCTION

Suction accumulators are used as a protective vessel to prevent liquid refrigerant from flooding into the compressor and protect it from damage. Suction accumulators are used to separate gas from liquid. When saturated – in both gas and liquid states - refrigerant flows from the evaporator to the accumulator, the liquid by gravity precipitates at the bottom of the accumulator and the gas flows towards the compressor suction through a port at the top of the accumulator.

## 1.4.5 PIPING ARRANGEMENTS

Piping connects the components of the refrigeration system. The piping required to connect the evaporator to the rack and the condenser are often extensive. Some common techniques are circuits and loops



Figure 1-15. Suction accumulator

## Circuits

- In circuit systems, isolation ball valves, solenoids and EPR's are factory installed on the rack or remote header and piped individually to each group of cases/ coils in the store.
- For circuit systems each group of cases will have a liquid line and suction line at minimum.
- Control boards are normally located in the main rack con troll box control.



Figure 1-16. Example of a Rack for a Circuit System



Figure 1-17. Piping for a Circuit

## Loops

- Loops typically are isolated and controlled directly or close to the case or evaporator.
- Isolation ball valves, solenoids and EPR's are shipped loose for field installation and located at the fixture or close to it.
- Valves and controls are installed by the refrigeration contractor
- EPR valves for loop systems are typically limited to types that do not require a piloted pressure to actuate but still have a solenoid stop feature to close the valve
- SPORT, SPORT II , SORIT PI, CDS,
- Systems that will require loop piping or a remote header if conventional piping is desired are: DSS, DV, DSP, FX as these systems are designed as a loop configuration.



Figure 1-18. Example of the single pair of in a loop configuration leaving/returning to the rack (before being hooked up)

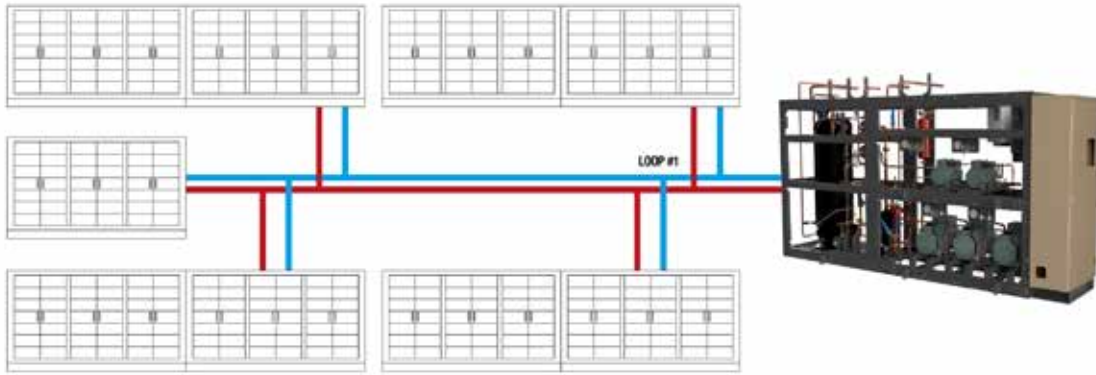

Figure 1-19. Example of a loop configuration

## 1.5. OPTIONS

### 1.5.1 HEAT RECLAIM

Heat reclaim is the process of reclaiming heat that would normally be rejected through an outdoor condenser. This heat is therefore wasted, heat reclaim captures this potential energy for other uses and can significantly lower overall energy costs.

Typically, the refrigerant is diverted to a heat exchanger or to a heat recovery system such as a Thermo-Stor tank in an area that requires heat. One of the older applications of heat reclaim is in a supermarket, since a supermarket has a constant supply of heat removed from the many refrigerated display fixtures and coolers. While the most popular application of heat reclaim is air, water heating is popular in supermarkets, convenience stores and restaurants, which all use considerable amounts of hot water. Essentially any application that requires heat can use the potentially wasted heat from a refrigeration or air conditioning system. The energy efficiency gained by recovering heat reduces costs. Figure 1-20 is a piping and instrumentation diagram that shows a refrigeration system with a heat exchanger or a Thermo-Stor option at the upper left corner providing heat to water.

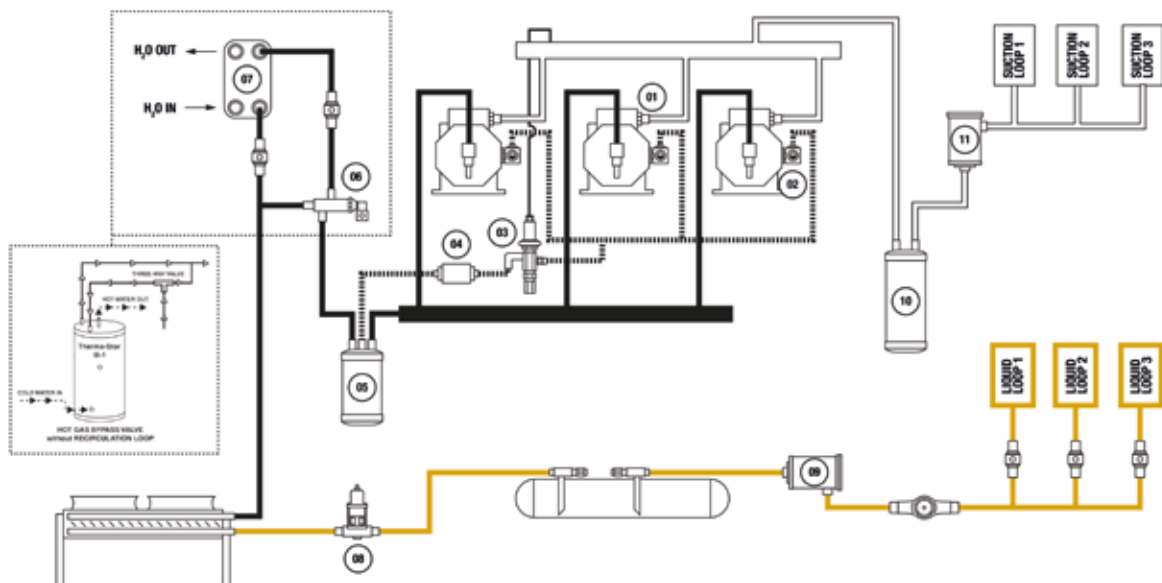

Figure 1-20. Heat reclaim diagram illustration with Call-Outs Defined Below

<b>1</b> Compressor	<b>2</b> Oil Level Control	<b>3</b> Pressure Reducing Valve
<b>4</b> Oil Filter	<b>5</b> Oil Separator/Reservoir	<b>6</b> Heat Reclaim 3-Way Valve
<b>7</b> Heat Exchanger	<b>8</b> Condenser Returning Valve	<b>9</b> Filter Drier
<b>10</b> Suction Accumulator	<b>11</b> Suction Filter	

## 1.5.2. SUBCOOLING

Subcooling (Figure 1-21) is the condition where the liquid refrigerant is colder than the minimum temperature (saturation temperature) required to keep it from boiling and, hence change from the liquid to a gas phase.

The amount of subcooling at a given condition, is the difference between its saturation temperature and the actual liquid refrigerant temperature. It is desirable because subcooling:

- Increases the efficiency of the system since the amount of heat being removed per pound of refrigerant circulated is greater. In other words, you pump less refrigerant through the system to maintain the refrigerated temperature you want. This reduces the amount of time that the compressor must run to maintain the temperature.
- Prevents the liquid refrigerant from changing to a gas before it gets to the expansion valve. Pressure drops in the liquid piping and vertical risers can reduce the refrigerant pressure to the point where it will boil or “flash” in the liquid line. This change of phase causes the refrigerant to absorb heat before it reaches the evaporator.

The effects of subcooling shown in a log P-h graph (Figure 1-22). Increasing the subcooling from (c-d) to (c-e) increases the corresponding available cooling capacity inside the evaporator from (a'-d') to (a'-e').

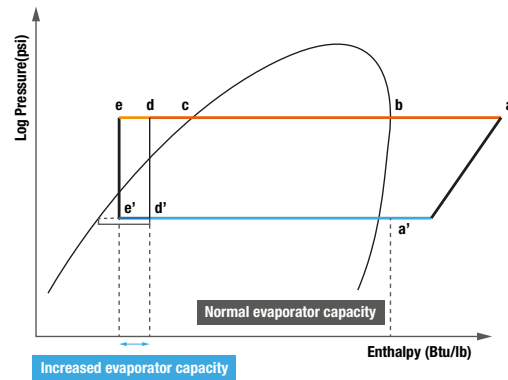

Figure 1-21. Example P-h Graph Showing the increased System efficiency as a Result of Subcooling

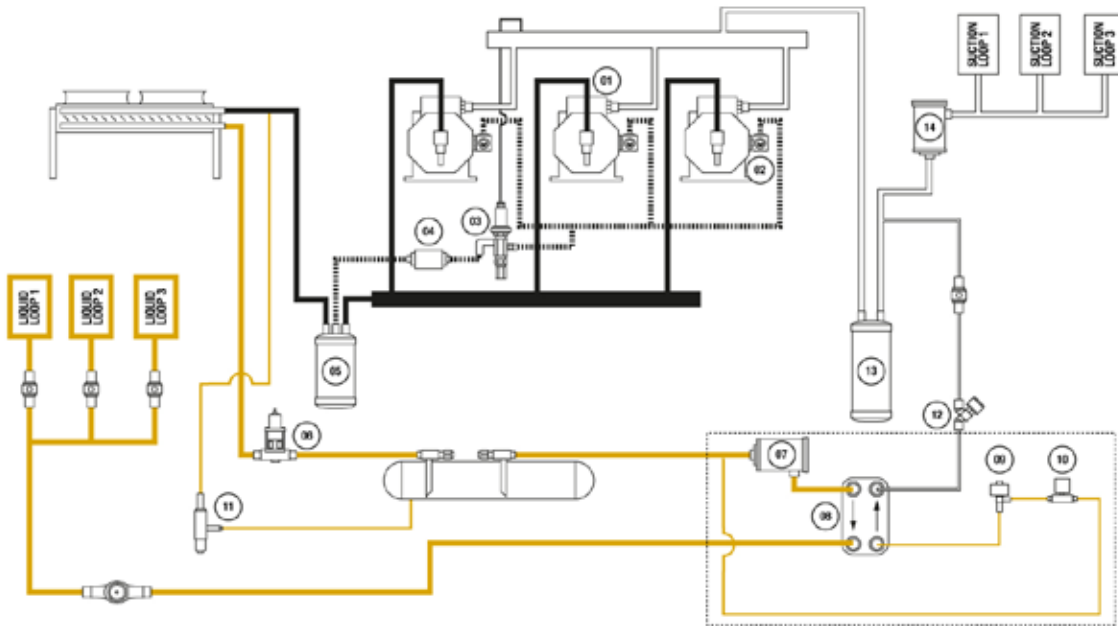

Figure 1-22. Sub cooling diagram illustration with the identification of Components Below

1	Compressor	2	Oil Level Control	3	Pressure Reducing Valve
4	Oil Filter	5	Oil Separator/Reservoir	6	Condenser Returning Valve
7	Filter Dryer	8	Heat Exchanger (Subcooler)	9	Electronic Expansion Valve (EEV)
10	Solenoid Valve	11	Receiver Pressure Valve	12	Electronic Evaporator Pressure Regulator (EEPR)
13	Suction Accumulator	14	Suction Filter		

### 1.5.3. SPLIT CONDENSER

Split-Condensers (Figure 1-23) are used in large refrigeration systems to assist in head pressure control and to minimize the amount of system refrigerant charge required. The size of the condenser required for summer operation is normally split into two parallel circuits. One circuit (designated “summer/winter”) is active all year long. The other circuit (designated “summer condenser”) is rendered inactive during winter operation by a 3-way split condenser valve or other means like solenoid valves or motorized valves.

Head pressure controls are used to maintain minimum and stable head pressures. The two condensers are usually split 50/50 in size and are contained in the same “tube bundle” using condenser fan control as a supplement to the head pressure control valves. With this combination, the required refrigerant charge is kept to a minimum.

Figure 1-23 shows simplified piping and instrumentation diagram circuits.

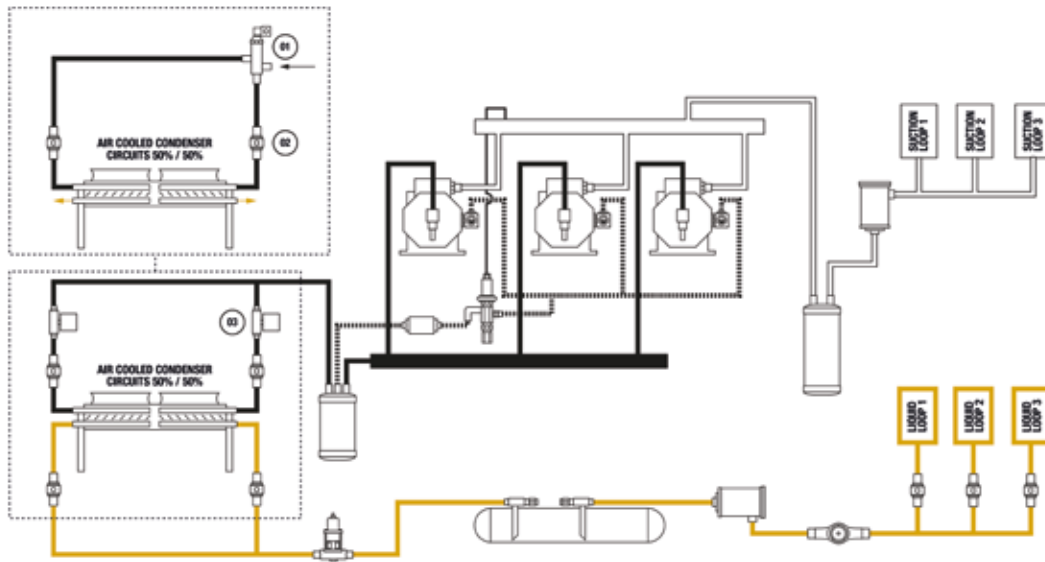

Figure 1-23. Split condenser diagram illustration

- 1** Split Condenser Valve
- 2** Ball Valves
- 3** Solenoid Valve

### 1.5.4. HOT GAS DEFROST

Hot gas defrost (Figure 1-24) is one of the most common method to melt the frost formed on an evaporator. Performing a quick and efficient defrost reduces costs and contributes to reduced energy consumption within the refrigeration system. The defrost process could be divided into 4 main sections. First, the liquid supply to the evaporator is shut off. Evaporator fans should still run for sometime, suction valve remains open in order to make sure that remaining liquid refrigerant will boil out. Second, the suction valve will be closed, evaporator fans will be stopped, the hot gas solenoid valve will be opened and the feed of the evaporator with the hot gas starts. Third, when the defrost is finished, the hot gas solenoid valve will be closed, the suction valve will be opened. Finally, the liquid feed is opened again, water droplets on the evaporator fins are allowed to freeze, and only then the evaporator fans will be started again.

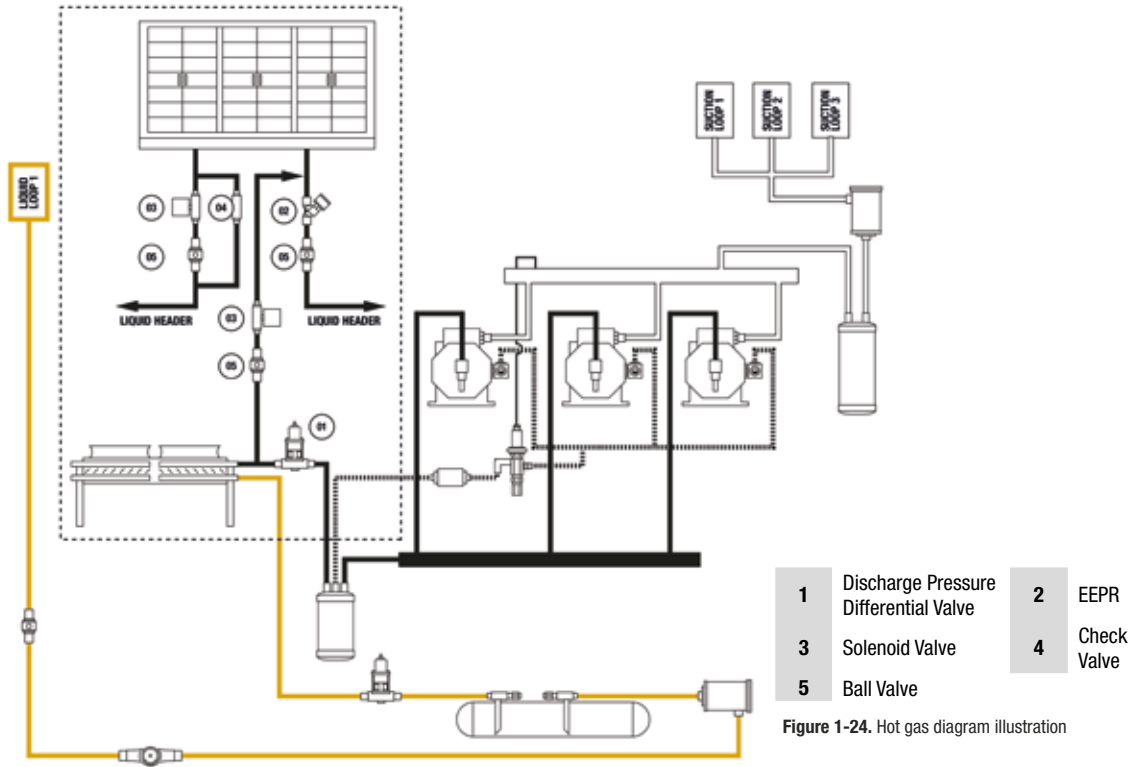

Figure 1-24. Hot gas diagram illustration

HFC

MANUAL

# 2

## SAFETY INFORMATION



**KYSOR WARREN**  
eptarefrigeration

## 2. SAFETY INFORMATION

This section describes general safety information, markings, protective gear, and refrigerant specific information. Personnel should follow these and local safety precautions and regulations when working around HFC refrigeration systems.

### 2.1. SAFETY

- The installation, commissioning, maintenance and disassembly of this system must be carried out by trained and qualified personnel for this type of equipment.
- Before equipment is worked on, it is pressurized with dry air or inert gas.
- All equipment piping must be evacuated before charging the system with refrigerant.
- Make sure that all field wiring conforms to the requirements of the equipment and all applicable national and local codes.
- Avoid contact with sharp edges and coil surfaces. They are a potential injury hazard.
- Before working on the system, ensure all power sources are disconnected.



Figure 2-1. Examples of cautionary and safety signage



Figure 2-2. Examples of types of protective equipment

### 2.2. GENERAL SAFETY INFORMATION

Owners are responsible for the display of cautionary / safety signage. Caution signage should be installed on the premise at entrances to the equipment room or areas near installed equipment. Figure 2-1 shows examples of cautionary/safety signage.

### 2.3. PERSONAL PROTECTIVE GEAR

Technicians and support staff are responsible for using proper protective gear. All staff working on this type of equipment should use personal protective equipment such as gloves, glasses, and safety shoes.



HFC

MANUAL

# 3

## INSPECTION AND **PLACEMENT OF MATERIAL**



**KYSOR WARREN**  
eptarefrigeration

### 3. INSPECTION AND PLACEMENT OF MATERIAL

Materials at the construction site should be thoroughly inspected upon unloading for damage, missing parts and serviceability.

#### 3.1 INSPECTION OF MATERIALS

Inspect the HFC refrigeration system and accessories for damages or shortages before and during unloading.

If there is any damage, notify the carrier immediately and request an inspection. Ensure:

- The delivery receipt is annotated that the equipment was received damaged.
- If damage is not noticeable on receipt, contact the carrier immediately when the damage is discovered.

It is the responsibility of the consignee to file all claims for damage with the transportation company.

##### 3.1.1. ACCESSORIES

Be sure that you receive all items. They are packaged separately.

Check the packing list against the contents.

- All parts are present

#### NOTE

If parts are missing, contact the Technical Sales Support (TSS) or the point of contact listed in the packing list.

##### 3.1.2. SYSTEM PRESSURE

- Pressure in the system is within specified limits.

#### NOTE

The system is shipped with a 50 psi holding charge of dry nitrogen. Report lack of or a reduced pressure immediately to the KW technical sales support.

##### 3.1.3. ELECTRICAL

- Specifications on electrical data plate matches on-site power configuration.

##### 3.1.4. COMPATIBILITY OF FIELD INSTALLED MATERIAL

- Field installed material meets manufacturer's specifications.

##### 3.1.5. MATERIALS MEET SPECIFIED PRESSURE RATINGS

- Field Installed material meets specified pressure ratings.

### 3.2 RATING PLATE

The rating plate (Figure 3-1) provides information for the model. Verify the information on the data plate corresponds to the model ordered.

- The model on rating plate is the same as the model ordered.
- The supply voltage is the same as required by the unit.
- The refrigerant is correct.
- The maximum and minimum design pressures match.
- The number and specifications for each compressor is correct.

HEATCRAFT  
Visit us at [www.kysorwarren.com](http://www.kysorwarren.com)

Model: TD400-072-VC-4-NX2F-8 Refrigerant: R407A  
Serial Number: S16G00002 Outdoor Use: No  
Minimum Design Pressure (High/Low Sides): 335 /177 PSI  
Condenser Type and Minimum Design Pressure: REMOTE AIR-COOLED 400 PSI  
Primary Electrical Circuit: 460 V 60 Hz 3 P  
Max Overcurrent Protection: 250 Amps  
Minimum Circuit Ampacity: 225.4 Amps  
Secondary Electrical Circuit: 208 V 60 Hz 1 P  
Max Overcurrent Protection: 15 Amps  
Minimum Circuit Ampacity: 12.0 Amps

Individual Compressor Data:

Compressor	HP	RLA	LRA
1	18.0	42.2	235
2	18.0	42.2	235
3	18.0	42.2	235
4	18.0	42.2	235
5	HP	RLA	LRA
6	HP	RLA	LRA
7	HP	RLA	LRA
8	HP	RLA	LRA
9	HP	RLA	LRA
10	HP	RLA	LRA
11	HP	RLA	LRA
12	HP	RLA	LRA

UL US LISTED  
Condensing Units 42BU  
Kysor/Warren  
Assembled in US  
5 Corporate Ridge Park

Figure 3-1. Data Plate

#### NOTE

Each rack has a data plate and a legend on the front or the inside of the electrical panel

### 3.3 LIFTING INSTRUCTIONS

Each rack system has lifting lugs built into the structure. Failure to lift the unit properly can cause damage to the unit or bodily harm to people in the area.

- ❑ Spreader Bar(s) are used for all rigging or use alternative rigging arrangements illustrated below.
- ❑ Use ALL lifting lugs provided on equipment.
- ❑ Lifting cables and other lifting equipment should not be in contact with piping or electrical components
- ❑ Adjust tension on the lifting straps to equalize the weight of the rack when lifted
- ❑ Before draining water, ensure that adequate drainage is installed behind the unit to collect and properly discharge the water.
- ❑ Unpack the unit at the installation site.

### 3.4 PLACEMENT OF EQUIPMENT

Good positioning at the site of the refrigeration equipment:

- Reduces costs
- Permits the free flow of air around the system.

#### NOTE

KW provides information on the equipment weight and the location of lifting lugs. It does not provide detailed lifting instructions because:

- Of the wide variety of conditions and equipment at the construction site.
- The responsible personnel on site are best qualified to determine the specific materials required to lift the equipment.

#### 3.4.1. RACK SYSTEM

##### Outdoor Location of Equipment

- ❑ The mounting platform or base is level and permits free air flow. (also see recommendations for free air flow).
- ❑ Units are not located near steam, hot air or fume exhausts.
- ❑ The unit is mounted away from noise sensitive spaces such as offices.
- ❑ The unit has adequate support to avoid vibration and to reduce noise transmission into the building.

### LIFTING EQUIPMENT

Kysor Warren Epta US provides information on the weight of the equipment and the location of lifting lugs. Being at the site, the contractor is best qualified to determine the specific materials required to lift the equipment. Figure 3-2 shows an example of a shackle attached to a lifting lug. Figures 3-3 and 3-4 show examples with a front and side view, of the lifting arrangement for a condenser unit. Figures 3-5 and 3-6 show examples of lifting a Weather Enclosed Hybrid (WEH).

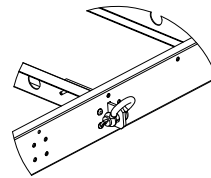

Figure 3-2. Example of a shackle and Lifting Lug

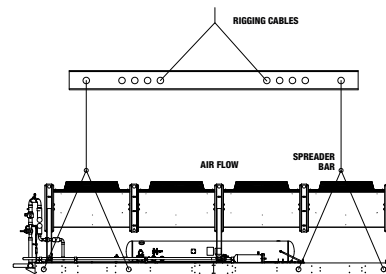

Figure 3-3. Side view

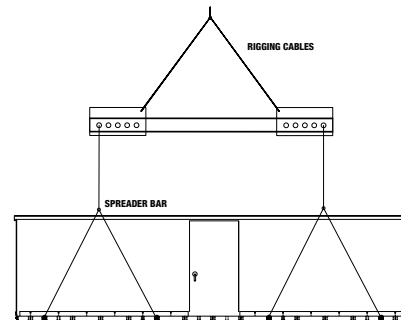

Figure 3-5.

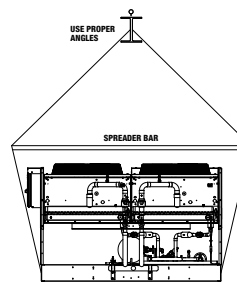

Figure 3-4.

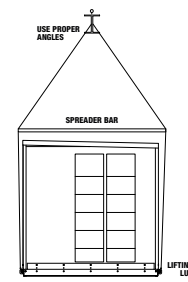

Figure 3-6.

## Equipment Mounted on the Ground



Figure 3-7. Rack Mounted on Floor

The foundation is:

- Set on a flat and level foundation
- Is designed to support the weight of the equipment
- Isolated from the building structure.
- Rechecked to ensure it is level prior to tightening the bolts.

## Equipment Mounted on the Roof



Figure 3-8. Equipment Mounted on roof

- The structure is strong enough to support the weight of the unit and service personnel.
- The structure minimizes deflection and vibration transmission

### Ventilation

- Ventilation is in the range of 40-100 cfm per compressor horsepower depending upon ambient temperatures or as specified by the customer.
- The air intake is positioned and sized so that air passes over the units at a maximum velocity of 500ft/minute velocity.
- Check national and local codes and use the larger of the manufacturer's recommendations and national/local codes.

## Reducing Vibration

- Vibration isolation pads (Figure 3-7) are used.
- Isolation hangers are used when refrigeration lines are suspended from the structure.
- Packed fiberglass and sealing compound are used when piping passes through walls.
- If required, special vibration absorbing spring mounts (optional equipment), Figure 3-8) are placed under the base frame of each unit.



Figure 3-9. Example of a Vibration Isolation Pad



Figure 3-10. Example of a Vibration Absorbing Spring Mount

### 3.4.2 LOCATION OF THE CONDENSING UNITS

The location of the air-cooled condensing unit allows an adequate supply of air to cool the unit.

Otherwise, higher head pressures will occur and cause poor operation and potential equipment failure.

Other considerations include:

- Do not locate condensers near steam, hot air or fume exhausts.
- Corrosive atmospheres may require custom designed condensers.
- Locate units away from noise-sensitive areas.
- Provide adequate support to avoid vibration and noise transmission.
- Provide sufficient room for maintenance, service, and personnel access.

### Recommendations for the Placement of Condensing Units

#### NOTE

The factor used in determining the placement of condensing units is the width of the narrow part of the unit. This is identified as "W" in the text and drawing

## Walls and Obstructions

- Units are located a minimum of  $W$  away from any wall or obstruction.
- There are no overhead obstructions
- A minimum air space of  $2W$  is required for any unit with walls or obstructions on three sides.

## Units in Pits

- The minimum distance from the sides is  $2W$ .
- The top of the condensing unit should be level with the top of the pit
- If the top of the condensing unit is below the top of the pit, then discharge cones or stacks are used.

## Multiple Units

- The minimum distance for units placed side-by-side is the width of the largest unit.
- The minimum distance for units placed end-to-end is 4Ft

## Decorative Fences

- There are no minimum distances for units enclosed in decorative fences if the decorative fences:
  - Have 50% or more free area
  - Have One foot or more of undercut
  - Do not exceed the top of the unit.
- If the fence does not meet the requirements above, then modify, remove, or replace the fence.

### NOTE

#### Not recommended

- Air flow going from the condensing unit to an obstruction
- Air flow going in the same direction through multiple condensers
- Side by side units have air flowing toward each other.

## Walls or Obstructions for Horizontal Air Flow

Clearance from wall or obstructions

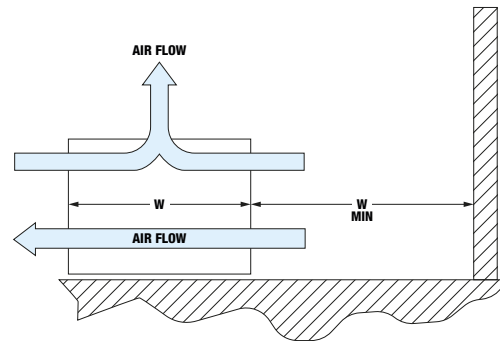

Figure 3-11. Minimum Distance from Walls and Obstructions

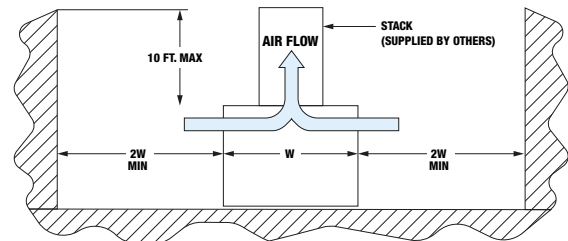

Figure 3-12. Minimum Clearances in Pits

## Multiple Units with Horizontal Air Flow

Clearance for multiple units placed side by side

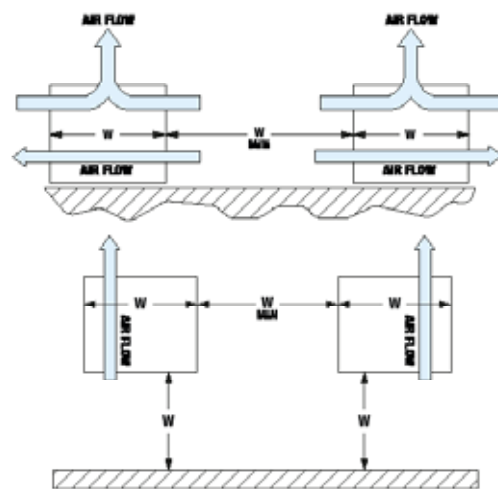

Figure 3-13. Minimum Clearance for Multiple Units

## Clearance for fence enclosures

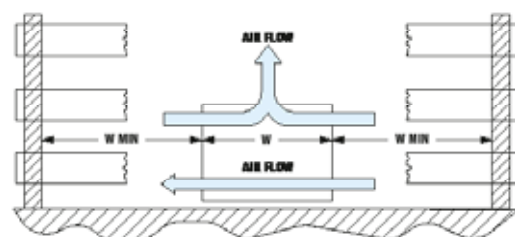

Figure 3-14. Minimum Clearance for Decorative Fences

HFC

MANUAL

# 4

## SYSTEM **INSTALLATION**



**KYSOR WARREN**  
eptarefrigeration

## SYSTEM INSTALLATION

### 4.1. GENERAL

Installation of the refrigeration must comply with the “Safety Standard for Refrigeration Systems” (ANSI/ASHRAE Standard 15), ASME B31.5 Refrigeration Piping Standard, and local building codes.

#### NOTE

Customer is solely responsible for compliance with local codes and regulations.

- Properly sized refrigeration lines are essential. Suction lines are more critical than liquid or discharge lines. Consult the technical manual or legend sheet for proper line sizes.
- Do not run refrigeration lines from one system through cases on another system.
- Refrigeration lines should never be placed in the ground unless they are protected against moisture and electrolysis attack.
- Main trunk lines should enter a line-up of cases in the center.

### 4.2. RESPONSIBILITIES

Table 4-1 lists a suggested the division of responsibilities for the installation of the refrigeration systems are generally divided between KW, the client, and the installer. The client however, has the final say on who is responsible. The important thing is to clearly identify who is responsible for each action.

Action	Kysor Warren Epta US	Store Owner	Installer
Code compliance		<b>X</b>	
Caution Signage per Local Code		<b>X</b>	
Inspection of material			<b>X</b>
Component specifications	<b>X</b>		
System Specifications	<b>X</b>		
Store Layout		<b>X</b>	
Installation of System			<b>X</b>
Interconnection of System			<b>X</b>
Operational Testing			<b>X</b>

Table 4-1. Suggested Division of Responsibilities

### 4.3. FIELD PIPING

Field piping must be installed according to the refrigeration schedule / drawings provided by the Store Owner.

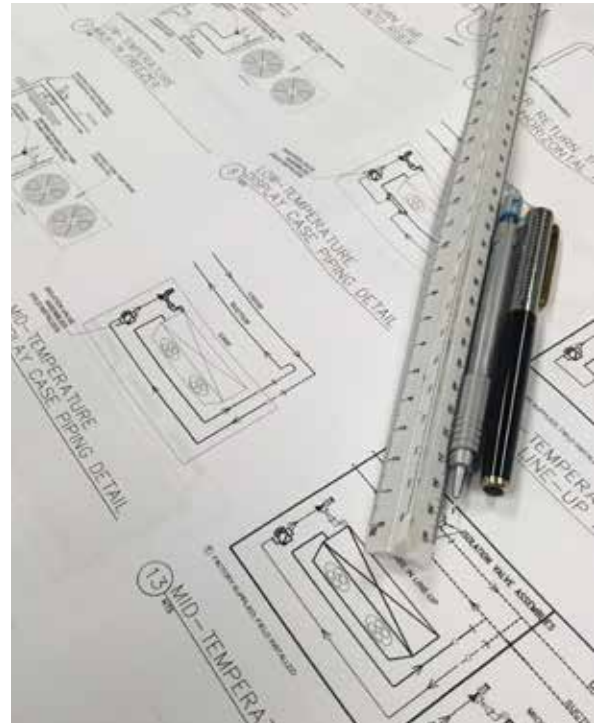

#### UNDER-FLOOR AND UNDERGROUND PIPING:

- Has the disadvantage of having no access for future service, troubleshooting, and repair.
- A minimum of 1” insulation is used inside of PVC piping or equivalent rigid pipe
- Voids between the insulation and the PVC pipe, where the insulated piping exits the PVC, should be filled with expanded polyurethane foam to prevent air from entering the pipe.

#### General:

- Installing low temperature lines through non-conditioned areas is not recommended due to additional heat load, deterioration of insulating material, and corrosion of piping.
- Use strap and support tubing to prevent excessive line vibration and noise where needed.

#### 4.3.2 PIPE LINE SIZING

- Piping lines are installed according to the drawings and customer specifications
- Changes to diameters and materials are confirmed and documented

### 4.3.3 PIPING INSTALLATION

- Piping dimensions and capacities meet or exceed maximum operating pressure and temperatures.
- There is adequate clearance between pipe and adjacent walls and hangers to allow for service and inspection.
- Pipe sleeves are used through walls, floors, and ceilings.
- Pipe sleeves must permit installation of pipes with full thickness insulation.

### 4.3.4 CASE & UNIT COOLER PIPING

#### NOTE

For multiple cases, the liquid distribution and suction gas pipelines should be internally installed. However, they can be externally installed.

#### Liquid Lines

- Liquid lines are sized for a minimum pressure drop to prevent flashing. Flashing in the liquid lines would create additional pressure drop and poor expansion valve operation.

#### Suction Lines

The suction lines carry expanded vapor back to the compressor from the evaporators and should be insulated. The suction lines may travel horizontally or vertically to the refrigeration rack. Any suction line that travels vertically and the direction of refrigerant flow inside it is against gravity, is called a **suction riser**.

Refrigerant flowing through suction risers are unable to carry the lubrication oil through the pipes to the compressor due to the low flow velocity. Oil traps are designed into the suction risers.

- The reducer fitting must be placed after the elbow.
- Suction lines going to a compressor have a minimum drop of a 1 inch per 20 feet.
- Suction lines do not have dips to trap oil.
- Inverted traps are in place where multiple suction lines enter a main trunk line..

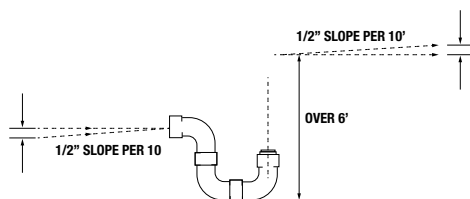

Figure 4-1. Slopes for Suction Lines

### 4.3.5 EXPANSION JOINTS

Expansion joints should be designed into the system to provide strain relief. Piping strain and stress occur due to thermal expansion of pipes, and to vibration primarily from compressors.

- Expansion joints are designed by adding a “Z-bend” or change in direction at areas of concerns.
- Long straight runs of pipe should include extra changes in direction for accommodate expansion.

### 4.3.6 PIPE SUPPORTS

Pipe supports are used for all refrigerant piping.

Insulated pipes should use saddles to avoid tearing. The saddles:

- Can be metal or PVC (Poly Vinyl Chloride);
- Should have a smooth surface and the length of the saddle should be three times the diameter of the pipe including;
- Should be in contact with 1/3 of the insulated pipe perimeter;
- An air gap should be maintained between insulated pipes to avoid sweating;
- No support should have direct contact with the pipes to avoid heat gain and water seepage due to condensation.

Saddles are also used for underground piping, where insulated pipes are routed through trenches. Metal clamps are to be avoided as pipe support as they promote heat gain and vapor condensation

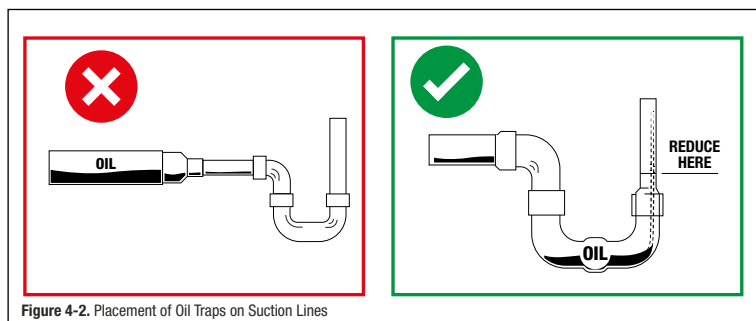

Figure 4-2. Placement of Oil Traps on Suction Lines



### 4.3.7 PIPING JOINTS

Copper joints are brazed with minimum 15% silver brazing alloy (filler) and for dissimilar metals use minimum 45% silver brazing alloy (filler). While brazing, nitrogen gas must flow through the pipe or tubing to prevent oxidation as each joint is brazed.

- Suction and liquid lines are not soldered or taped together.
- Limit the soldering paste or flux to the minimum required in order to prevent contamination on dissimilar metal

#### Threaded Joints

Threaded joints have a greater likelihood of leaking than brazed joints and should not be used. If used however, an approved high pressure sealant is required. KW recommends Loctite 545 to seal threaded joints. Teflon tape should not be used in combination with joint sealants.

#### Flared joints

Flared joints are not recommended by KW

NOTE
Piping must be properly sized to ensure adequate pressure when the condenser is separated from the compressor or is at a higher elevation.

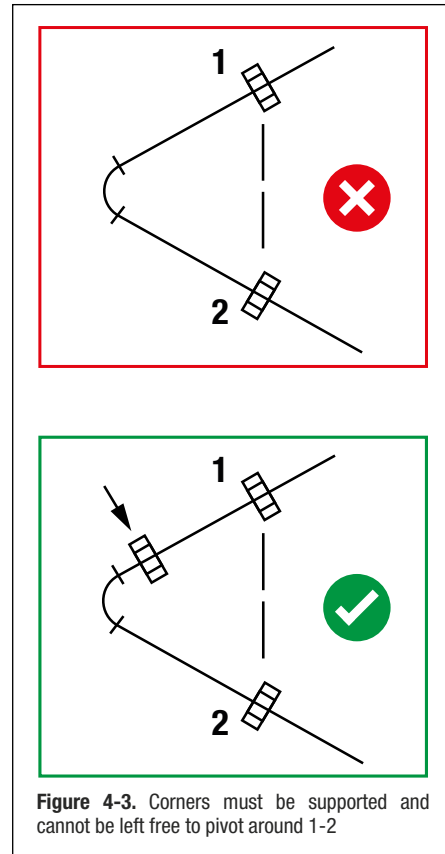

Figure 4-3. Corners must be supported and cannot be left free to pivot around 1-2

Piping should not disrupt or restrict refrigerant flow. Allowing sufficient “play” in the piping system and reducing abrupt changes in refrigerant direction reduces internal stresses and pressure drops. Short radius elbows for example, should be avoided if possible because they increase stress on the piping and cause the refrigerant to lose pressure.

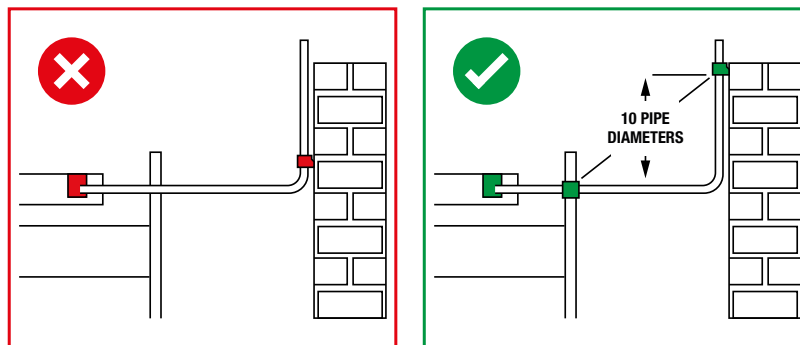

Figure 4-4. Corners support illustration.

Contractors install piping supports based on the plans and industrial standards. Straight lengths of piping for example below, must be supported at each end and have additional supports not more than every 8 feet. Cushioned clamps and pipe supports should be used to prevent contact between pipes.

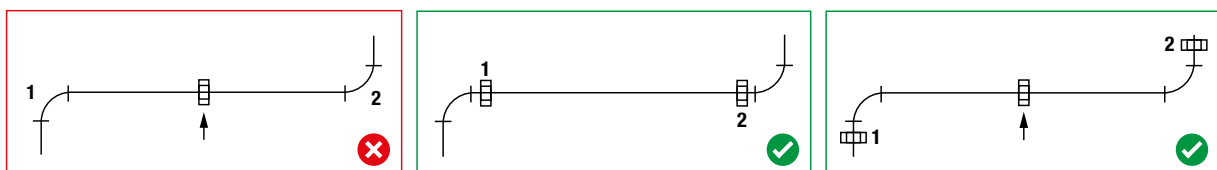

Figure 4-5. Corners support illustration.

## 4.4 TESTING AND EVACUATION

### 1. PRE-CHECK

- Visually inspect refrigerant lines and joints for proper piping assembly and installation
- Proper bracing is used throughout
- Inspect for any metal to metal contact
- Manually verify that all mechanical joints are tight
- Ensure all electrical connections are tight.
- Check phase monitor for correct polarity

### 2. ISOLATE COMPONENTS NOT SUITABLE FOR THE PRESSURE LEVELS

### 3. DISCONNECT OR BYPASS ALL DEFROST HEATERS

### 4. OPEN VALVES

- Ball valves to circuits, branches, satellites, condenser, heat reclaim, receiver, etc.
- Main liquid line solenoid valve
- Suction stop EPR valves
- Both sides of condenser and heat reclaim piping
- De-energize the solenoid valves which are normally open

### 5. CHECK FOR LEAKS

- System pressure is brought to a minimum of 300 psig.
- Verify pressurization at multiple system access points.

#### IF LEAK IS IDENTIFIED:

- Leak is isolated from rest of system
- Leak is repaired
- Area of repair is retested
- Area is re-pressurized to a minimum 300 psig
- All valves are re-opened
- After all leaks are repaired and retested, system stands unaltered for 24 hours with no greater than a +/- 1 PSIG change
- When system is ready to be evacuated, the nitrogen charge is released.

### 6. PRE-EVACUATION

- System is depressurized
- Evacuation pump and sensors working properly
- No contaminants are introduced
- Evacuation pump is connected to 3 points on rack
- Copper lines or approved vacuum hoses are required
- Vacuum pump is rated at 8 cfm as a minimum and can reach all parts of the system.

- Vacuum pump oil as recommended by manufacturer (use new and clean oil)
- Electrical connections are secure and uninterrupted
- There are no leaks at the vacuum pump connections.

#### Lines and Valves

- Copper lines or suitable hoses are used.
- Packless valves are used
- All schrader valve caps are tightened and checked.
- All access valve caps are tightened

#### Micron Vacuum Gauge

- Gauge is properly calibrated
- Verify with gauge that pump can pull a vacuum of at least 300 microns
- Vacuum is measured at a minimum of two points which are at extreme points within the system

### 7. TRIPLE EVACUATION PROCEDURE

#### 1st Evacuation

- Pull a system vacuum down to at least 1,000 microns (+/- 50 microns) and close the vacuum header valves.
- If system cannot maintain a vacuum and returns to atmospheric pressure, check and correct leak(s) as previously described
- When system maintains a 1,000 micron vacuum for 30 minutes, break the vacuum with dry nitrogen to a pressure of 2 psi
- Install system suction and liquid drier cores.

#### 2nd Evacuation

- Pull a second vacuum to a minimum of 500 microns.
- Close vacuum header valves.
- If the 500 micron vacuum holds for a minimum of 30 minutes, then break the vacuum with the refrigerant to be used in the system to a pressure of 2 psig.
- Install system suction and liquid drier cores.
- Add oil to the compressors, oil separator and oil reservoirs, if equipped before starting compressors

#### 3rd Evacuation

- Pull a third vacuum to a minimum of 300 microns.
- Close vacuum header valves and allow system to stand for a minimum of 24 hours
- System is ready to be charged with refrigerant If the 300 micron vacuum holds for 24 hours with a maximum drift of 100 microns over the 24 hour period.
- Break the vacuum with the refrigerant to be used in the system and charge the system with refrigerant.
- Add oil to the compressors, oil separator and oil reservoirs, if equipped, before starting compressors.

## 8. CHARGING

Leave open the following:

- Ball Valves – to circuits, satellites, condenser, heat reclaim, receiver
- Main liquid line solenoid valve - should now be under control of the electronic controller
- Branch circuit liquid line solenoid valves – back out manual open stems
- Suction Stop EPR – should now be under control of the electronic controller
- Split condenser – should be operating under pressure controls
- Verify operation of condenser fans and rotation direction
- Verify operation of case and evaporator fans to avoid flood back
- Close ball valve immediately downstream of the receiver.
- Connect proper refrigerant tank to receiver access port through a liquid line drier.
- Charge receivers to 60% on the liquid gauge or to the point of pressure equalization
- Disconnect refrigerant tank from the receiver access port
- Open ball valve immediately downstream of the receiver

Complete charging system by connecting proper refrigerant drum to the suction header.

- Start the compressor with the lowest capacity rating to speed up charging process
- Isolate refrigerant circuit liquid line and charge through that port
- Charge system to 30% minimum of the receiver on the liquid gauge
- Set compressor and all pressure controls
- Suction pressure should remain below setpoint
- Turn on additional compressors as needed
- Additional oil charge may be needed once system is fully charged.

## 9. FINAL CHECK

Conduct a complete walk-through of the system with a leak detector to make sure no leak has occurred in mechanical fittings due to vibration or pipes rubbing together.

## 4.5. INSULATION

Insulation is required on piping for the following reasons:

- Reduce heat transfer to the refrigerant and fluid lines
- Prevent condensation and ice formation on pipe surfaces
- Minimize corrosion of piping



Figure 4-6. Pipe Insulation

### Conditions

Insulation material is typically rated for either normal conditions (indoor applications), or severe conditions (outdoor applications). Insulation designed for severe conditions should also be used near exterior openings, non-conditioned areas, or areas with high temperatures and humidity.

### Materials

The recommended insulation material is be made from closed-cell elastomeric foam.

### Insulation Thickness

Refer to customer specifications, installation plans, or use industrial standards. KW recommends:

- ½" wall for medium temperature
- ¾" wall for low temperature

### Allow access

- Insulation is applied to allow access during component servicing. This includes all valves, controls, and fittings on refrigerant fluid lines.
- Insulate components to minimize air pockets or voids. These can collect moisture and cause corrosion.
- Insulation manufacturers provide detailed guidelines and training programs for installing insulation.

## 4.6 ELECTRICAL

Refer to project Schedule / Legend of Equipment Load and Electrical Requirements for details.

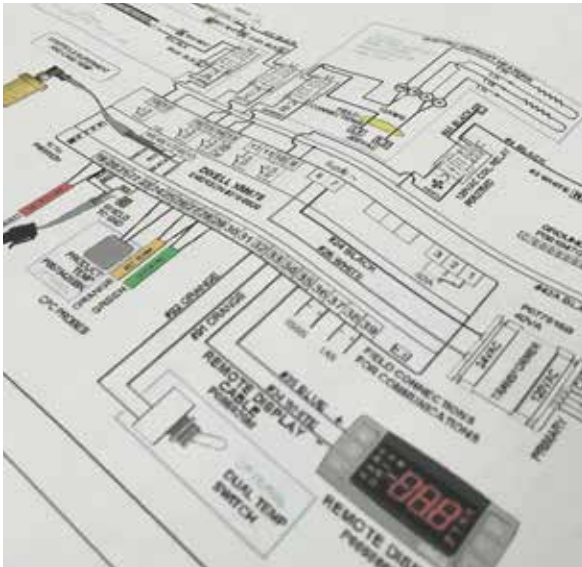

Figure 4-7. Review Electrical Drawings

HFC

MANUAL

# 5

## SYSTEM **OPERATION**



**KYSOR WARREN**  
eptarefrigeration

## SYSTEM OPERATION

Once the system installation is complete, all piping has been evacuated to specification, and all equipment is powered-up and ready to operate; the initial startup of the HFC System is done with the following steps:

### 1. SYSTEM POWER 2. INITIAL CHARGING

### 3. STARTING COMPRESSORS 4. FINAL CHARGING

### 5. CONTROLS AND PROGRAMMING

### 6. EVAPORATOR OPERATION

#### 5.1. SYSTEM POWER

- Power has been turned on to each subsystem
- Control Panel is energized;
- Panel switches are set with compressor OFF;
- Check operation of cooling fans;
  - Air cooled Condenser Fans Operating;
  - Case Fans Operating;
- Controls, gauges, and thermometers are displaying temperatures and pressures within acceptable ranges.;
- Check voltages to ensure correct specifications.

#### 5.2. INITIAL CHARGING

##### Oil Charge to the Oil Reservoir

- Confirm that oil is compatible with compressors;
- Close valves to isolate oil reservoir;
- Fill reservoir with 50% oil;
- Open valve between oil reservoir and compressors;

##### Oil charge to Compressors

- Check that the compressor oil is at the proper level;
- Confirm that the compressor crankcase heaters are energized.



Figure 5-1. System Power



Figure 5-2. Initial Charging

### NOTE

Oil is typically provided with the compressors. Oil level requirement may vary with compressor manufacturer. Crankcase heater must be operating to warm the oil prior to starting the compressor

#### 5.2.2 REFRIGERANT CHARGING

1.  Close main liquid supply valve;
2.  Introduce refrigerant through charging port as indicated on OEM literature;
3.  Charge to 30-50% of receiver capacity with largest circuit energized;
4.  Open valve between oil reservoir and compressors;
5.  All Other circuits should be isolated at this time;
6.  Only one compressor should be active. This should be the lowest capacity compressor in the system;
7.  Open isolation valve.

#### 5.3 STARTING COMPRESSORS

After charge with refrigerant, ensure that one compressor is active. This should be the lowest capacity compressor in the system.

1.  Energize compressor #1;
2.  Turn on larger circuit switch;
3.  Energize compressors as needed,

### NOTE

Use extreme care when starting the compressor for the first time. Slugging may damage the system if all of the oil and most of the refrigerant is located in the compressor. Recommend activating the crankcase heater 24 hours prior to start-up. Ensure the scroll compressors are running the proper direction or change phasing as needed.

### NOTE

Recheck oil and refrigerant levels after the unit has been running for 24 hours

#### 5.4. FINAL CHARGING

1.  Make sure compressor oil level is correct
2.  Refrigerant charge as specified by customer.



Figure 5-3. Refrigerant Charging



Figure 5-4. Starting Compressors

## 5.5. CONTROLS AND PROGRAMMING

### Mechanical Pressure Switches

Confirm that mechanical switches are operating properly. All pressure controls should be adjusted until they actuate and it is verified that the desired result is achieved. The controls should then be set to their proper setpoints (reference S00)

#### Adjust and verify the following:

1.  Low pressure control - Main
2.  Low pressure control - Satellite (cut in / cut out)
3.  High pressure control - Compressor
4.  Change separator element switch
5.  High separator differential switch
6.  Oil pressure reducing valve
7.  Condenser drain regulator
8.  Receiver pressure regulator (if provided)
9.  Receiver heater temperature sensor (if provided)
10.  Heat reclaim temperature sensor (if provided)

### Pressure & Temperature Sensors

Check that all pressure and temperature sensors are calibrated and providing accurate readings at the controller

#### EMS Setpoints

- Suction Pressure Deadband
- Compressor Stage Up Time Delay
- Compressor Stage Down Time Delay
- Condenser TD Target
- Minimum Condensing Temperature
- Maximum Condensing Temperature
- Rack High Pressure Alarm / LockOut
- Condenser High Pressure Override
- Split Condenser
- Subcooler enable
- Subcooler Superheat Target
- Subcooler Electronic Evaporator Pressure Regulator (EEPR) Target (initial)

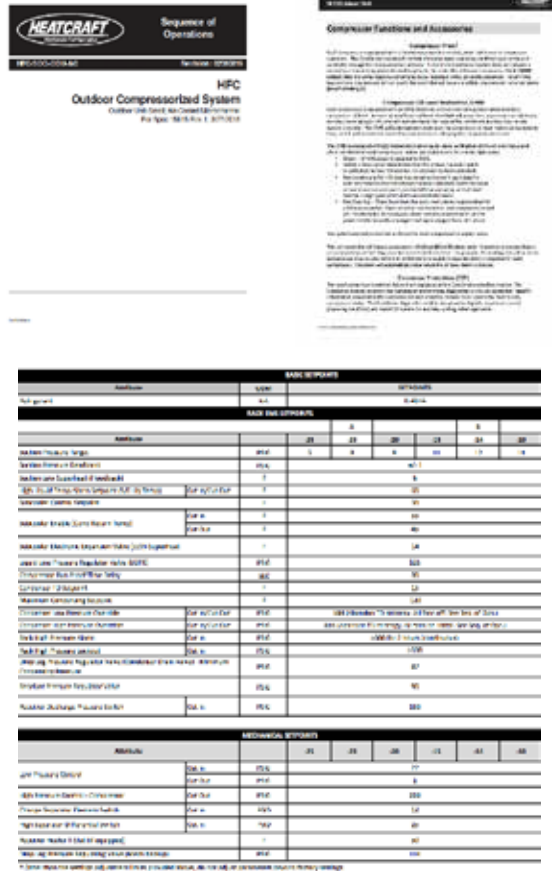

Figure 5-5. Example System Operating Instructions





- Subcooler EEPR Upper Limit
- Subcooler EEPR Target (initial)
- Subcooler Control Target
- High Liquid Temp Alarm
- Liquid Supply Pressure Target
- Stage 1 Leak Alarm
- Stage 2 Leak Alarm
- Ventilation Fans (if applicable)

### Digital Input Verification

Check that all digital inputs are reading open or closed as expected. Exercise each component and verify the results.

- Phase Loss Monitor
- Compressor Proofs
- Compressor Fails
- Variable Frequency Drive (VFD) Faults (if applicable)

### Relay Output Verification

All relay outputs should be exercised and the proper results verified.

- Compressor Runs
- VFD Bypasses (if provided)
- Subcooler Expansion Valve (Temperature and Pressure Control)
- Subcooler Expansion Valve (Superheat Control)
- Check Unloaders

### Relay Output Verification

- Connect VFD controller with Main Rack Controller

## 5.6. EVAPORATOR OPERATION

The final system operation procedures provide the final check of the complete refrigeration cycle and can be done following the steps below.

### 5.6.1 SETTING SUPERHEAT

#### NOTE

During service of this equipment, precautions should be taken to prevent loss of refrigerant to the atmosphere. Always install the expansion valve stem cap after making valve adjustments.

The expansion valve furnished with your case has been sized for maximum coil efficiency. To adjust superheat, perform the following

1.  Place a thermocouple near the expansion valve bulb. Read the suction line pressure as near to the coil as possible. If closest is at the condensing unit, estimate suction line loss at 2 PSIG.
2.  Convert coil suction pressure to temperature. The difference between coil temperature and the thermocouple temperature is superheat. Use average superheat when expansion valve is hunting.
3.  Do not set the superheat until cases have pulled down to operating temperature. Never open or close the valve over ¼ turn between adjustments. Allow 10 minutes or more between adjustments
4.  Superheat should be set at 6-10°F.
5.  After the initial setting, the superheat should be rechecked when product is stocked and at designated times.

#### NOTE

In case of using electronic expansion valve (EEV) the superheat should be set trough the case controller with the same values 6-10°F

## 5.6.2 EVAPORATOR TEMPERATURES

- With a digital thermometer, measure Display Cases / Evaporators and check their temperatures

## 5.7. DEFROST OPERATION

The standard system defrost design is off cycle and electric defrost. Defrost should be programmed to operate with 10% to 20% of system load/capacity at a time. This ensures that the system has sufficient cooling capacity to maintain the temperature of the system while recovering after defrost periods. Also display cases specification sheets need to be consulted to determine the number of defrost per day required for each case and to create the defrost schedule for the store.

Defrosting the evaporators is accomplished in three sequential steps:

### OFF CYCLE DEFROST

1. Stop refrigeration mode
2. Evaporator fans keep running until evaporator or discharge air temperature reaches the defrost termination temperature (specific for each case)
3. Re-start refrigeration mode

### ELECTRIC DEFROST

1. Stop refrigeration mode
2. Evaporator fan stops
3. Electric heaters are energized
4. Defrost termination temperature set-point or fail safe time
5. Drip time
6. Refrigeration valve opens
7. Evaporator fans run again.

The controller can be programmed to start and manage the defrost modes based on routine time periods, or based on temperature set-points.

**Installation &  
Operation Manual**

---

KW-IOM-2149
May 2016
Part No. 31E02149

**KYSOR / WARREN**  
**Reach-In  
Display Case**

**Models:**  
FXSSL  
FN7SL, FX6SL  
FN7SL, FX7SL  
(Low Temperature)

**Applications:**

**Contents**

Introduction—General Information	3
Plan and Cross Views	4
Case Data	6
Case Installation	12
Electrical Connections—General	16
Refrigeration Piping and Dehydration	29
ECM Evaporator Fan Operation	33
Replacement Part Descriptions	36
Warranty	37

**Installation and Operations**

**Case Data**

**FXSSL**

General Case Data	# of Doors			
	2	3	4	5
Total Display Area (ft <sup>2</sup> /Door)	24.0	36.1	48.1	60.1
Cubic Capacity	29.2	88.3	117.3	146.4
Total Daily Energy Consumption (kWh/Day)	11.5	17.0	22.4	28.8

**Refrigeration Data (HFC)**

Evaporator Temperature (°F)	# of Doors			
	2	3	4	5
Frozen Food	-10	-10	-10	-10
Ice Cream	-18	-18	-18	-18
Discharge Air Temp (°F)				
Frozen Food	-2 to -4	-2 to -4	-2 to -4	-2 to -4
Ice Cream	-8 to -11	-8 to -11	-8 to -11	-8 to -11
Discharge Air Velocity (fpm)	200-300	200-300	200-300	200-300
Fan Speed (rpm)	2000	2000	2000	2000
Superheat Setpoint (°F)	6 to 8	6 to 8	6 to 8	6 to 8
Estimated Refrigerant Charge (lbs)	2	3	4	5
Refrigerant Capacity (BTUH)				
Frozen Food	1800	2950	3640	4540
Ice Cream	1965	2945	3930	4910

**Electrical Data (Amps/Watts)**

208V/60Hz, 1 Phase				
Fans	0.36/30.0	0.54/45	0.82/68	1.00/78
LED				
Optima Pro	0.25/28.8	0.30/40.3	0.40/52.0	0.67/77.1
Quanta Starline	0.66/84.4	0.82/84.3	1.08/124.2	1.34/164.1
Anti-Sweat Heater	1.5/172.5	2.2/251.0	2.7/310.0	3.9/462.0
Defrost Fan Heater	0.30/44.0	0.65/74.8	0.78/90.7	1.16/133.4
208V/60Hz, 1 Phase				
Defrost Heater	6.73/1400	10.10/2100	13.46/2900	16.83/3500

**Defrost Data**

	Elec. Def.	Hot Gas
Defrosts per Day	1	1
Duration (min)	45	30
Termination Temp (°F)	65	47
Deg. Time (min)	0	2
Defrost Water (lb/day)	1.5-2.0	1.5-2.0

The above rating represents total kW to gross load. For detailed conditions, see conditions above. For more information, see the manual.  
Type 1 refrigerant, intended for use in an area where the environmental conditions are controlled and maintained that conditions do not exceed 70° F and 65% relative humidity. Kysor Warren Data US Worldwide Refrigeration, whose policy is one of continuous improvement, reserves the right to change at any time specifications, designs, or prices without incurring obligation.

**Installation and Operations**

**Expansion Valve and Superheat**

**CAUTION:** During service of this equipment, precautions should be taken to prevent loss of refrigerant to the atmosphere. Always install the expansion valve stem cap after making valve adjustments.

The expansion valve furnished with your case has been sized for maximum coil efficiency. To adjust superheat, perform the following:

1. Place a thermocouple near the expansion valve bulb. Read the suction line pressure as near coil as possible. If closest is at the condensing unit, estimate suction line loss at 2 PSIG.
2. Convert coil suction pressure to temperature. The difference between coil temperature and the thermocouple temperature is superheat. Use average superheat when expansion valve is hunting.
3. Do not set the superheat until cases have pulled down to operating temperature and never open or close the valve over 1/4 turn between adjustments and allow 10 minutes or more between adjustments.
4. Superheat should be set at 6-8°F.
5. After the initial setting, the superheat should be rechecked when product is stocked and at designed temperature.

**Superheat Calculations**

**Example 8-14**

→ 51°F Suction Temperature  
→ 28°F Suction pressure converted to temperature  
→ +23°F Superheat

Figure 5-6. Example KW Installation and Operation Manual for a Case

HFC

MANUAL

# 6

## MAINTENANCE AND **TROUBLESHOOTING**



**KYSOR WARREN**  
eptarefrigeration

## MAINTENANCE AND TROUBLESHOOTING

### 6.1. GENERAL MAINTENANCE PROCEDURES

Proper maintenance is critical to long term reliability and efficiency. For more detailed maintenance procedures, refer to the maintenance schedule or requirements for the specific system. The following are some general maintenance procedures.

#### 6.1.1. Initial Startup

Operators should be especially careful during initial startup procedures. The following are some recommended maintenance steps to take during initial startup.

- Change all filters and driers by end of first week of startup
- If filters are dirty, repeat in 7 days
- After 90 days:
  - Change the filter driers
  - Remove the suction line filter core
  - Replace oil coalescing media

Replaceable core suction filters are supplied for all units. The flanged shell holds replaceable pleated filter elements suitable for installation in the suction line of refrigeration systems. In this way any contaminants left in the system at start-up can be removed before they circulate back to the compressor. The suction filters are shipped loose for field installation.



Figure 6-1. Examples of Compressor Oil and Suction Filter

#### 6.1.2. SCHEDULED MAINTENANCE

Table 6-1 shows the recommended inspection items for a scheduled maintenance program.

Action	Weekly	Monthly	Yearly
Visually inspect equipment.	<input type="checkbox"/>	<input type="checkbox"/>	<input type="checkbox"/>
Check refrigerant charge.	<input type="checkbox"/>	<input type="checkbox"/>	<input type="checkbox"/>
Check compressor oil level and color.	<input type="checkbox"/>	<input type="checkbox"/>	<input type="checkbox"/>
Check compressor crankcase heater operation.	<input type="checkbox"/>	<input type="checkbox"/>	<input type="checkbox"/>
Check main power and control voltage.	<input type="checkbox"/>	<input type="checkbox"/>	<input type="checkbox"/>
Check appearance of area around the unit.	<input type="checkbox"/>	<input type="checkbox"/>	<input type="checkbox"/>
Check system pressures.	<input type="checkbox"/>	<input type="checkbox"/>	<input type="checkbox"/>
Check moisture indicator in liquid sight glass.	<input type="checkbox"/>	<input type="checkbox"/>	<input type="checkbox"/>
Check the system for leaks.		<input type="checkbox"/>	<input type="checkbox"/>
Check suction filters and liquid line filter driers for pressure drop.		<input type="checkbox"/>	<input type="checkbox"/>
Check all flanged connection bolts, fittings and line clamps for tightness.		<input type="checkbox"/>	<input type="checkbox"/>
Inspect condenser fan blades and motor mounts for cracks, loose set screws or mounting bolts.		<input type="checkbox"/>	<input type="checkbox"/>
Tighten all electrical connections.		<input type="checkbox"/>	<input type="checkbox"/>
Check operation and condition of contactors.		<input type="checkbox"/>	<input type="checkbox"/>
Check operation of auxiliary equipment.		<input type="checkbox"/>	<input type="checkbox"/>
Obtain oil sample for analysis; change oil if required.			<input type="checkbox"/>
Change liquid line filter drier and suction filter cores.			<input type="checkbox"/>
Test all operating and safety controls and record in service log book			<input type="checkbox"/>

Table 6-1. Recommended Scheduled Maintenance for a HFC Unit

**NOTE**

The above information is provided only as a general guideline to aid servicing personnel and equipment owners in maintaining equipment.

**NOTE**

Actual service intervals may vary from the recommended due to variables in the actual equipment application, operating conditions, and environment.

### 6.1.3 COMPRESSOR BURNOUT CLEANUP

The following is a recommended sequence to use in case of a motor burnout

- Determine the extent of the burnout. For mild burnouts where contamination has not spread through the system, it may be possible to save the refrigerant (see note below).
- Replace all strainers and filter-driers.
- Install a replacement compressor and make a complete electrical check.
- Make sure the suction line adjacent to the compressor is clean. Replace the liquid line filter-drier (or replaceable cartridge) designed for “cleanup”. (After 90 days, the suction line filter should be removed.)
- Install a burnout core in the liquid line shell.
- If the refrigerant is removed from the system, add charge as needed.
- Start the compressor.
- Record the pressure drop across the suction line filter and keep for reference.
- Replace the suction line filter-drier core(s) if the pressure drop becomes excessive. After 90 days, the suction line filter should be removed.

**NOTE**

The refrigeration charge can be saved if the system has service valves. A severe burnout exists if the oil is discolored, an acid odor is present and contamination products are found in the high and low side. With this condition, extreme caution should be exercised to avoid breathing the acid vapors and to prevent contaminated liquid from making contact with the skin. If needed, thoroughly clean and verify operation of system controls, such as expansion valves, solenoids, check valves, reversing valves, oil separators, suction accumulators, etc. In extreme cases, components have to be replaced.





	<b>AFTER 4 HOURS</b>	Observe the system during the first 4 hours. Replace filter cores as often as required until no further change in pressure drop is observed.
	<b>AFTER 48 HOURS</b>	After the system has been in operation for 48 hours, check the condition of the oil for acids. If the oil test indicates an acidic condition, replace the liquid and suction line filter- driers.
	<b>AFTER 2 WEEKS</b>	Check the system again after approximately 2 weeks of operation. If the oil is still discolored, or checks acid, replace the liquid and suction line filter-driers.  Cleanup is complete when the oil is clean, odor free, and is determined to be acceptable by testing for acids or other contaminants.  Replace the suction line filter-drier with suction line filters cores to minimize suction line pressure drop and to provide maximum compressor protection.
	<b>AFTER 90 DAYS</b>	Suction Line filter should be removed

Table 6-2. Compressor Burnout Time Line

## 6.2 TROUBLESHOOTING

Refrigeration systems are complex machines that often operate all the time. When a problem happens, it has to be quickly corrected or else expensive produce will be ruined.

Troubleshooting is a logical and systematic search for the source of a problem in order to correct the problem and make the system operational again in a minimal amount of time.

When troubleshooting a system, it is important to have a systematic approach to collecting and analyzing data. Table 6-3 is an example of a general troubleshooting process.

**NOTE**

Table 6-3 is an example only. Operators should develop a troubleshooting methodology for their own specific equipment.

	PROBLEM	POSSIBLE CAUSES	POSSIBLE CORRECTIVE STEPS
COMPRESSOR	Compressor will not run	Main switch open	Close switch.
		Fuse blown	Check electrical circuits and motor winding for shorts or grounds.
			Investigate for possible overloading.
			Replace fuse after fault is corrected.
		Thermal overloads tripped	Overloads are automatically reset.
			Check line.
		Defective contactor or coil	Repair or replace.
		System shut down by safety devices	Determine type and cause of shut-down and correct it before resetting safety switch.
		No cooling required	None. Wait until calls for cooling.
		Liquid line solenoid will not open	Repair or replace coil.
Motor electrical trouble	Check motor for open windings, short circuit or burn out.		
Loose wiring	Check all wire junctions. Tighten all terminal screws.		
	Phase loss monitor inoperative	Refer to Phase Loss manual. Make sure 3 phases of power are supplied to module	
Compressor noisy or vibrating	Flooding of refrigerant into crankcase	Check setting of expansion valves.	
	Improper piping support on suction or liquid line	Relocate, add or remove hangers.	
	Worn compressor	Replace compressor.	
	Scroll compressor rotation reversed	Rewire for phase change.	
	Oil levels too high	Reset oil float and/or drain excess oil from system.	
Compressor thermal protector switch open	Operating beyond design conditions	Add components to bring conditions within acceptable limits (i.e., CPR)	
	Discharge valve partially shut	Open discharge valve.	
	Blown valve plate gasket	Replace gasket.	
	Dirty condenser coil	Clean coil.	
	Overcharged system	Reduce charge.	
High discharge pressure	Non-condensable gas in system	Remove the non-condensable gas.	
	System overcharges with refrigerant	Remove excess.	
	Discharge shutoff valve partially closed	Open valve.	
	Fan not running	Check electrical circuit.	
	HPEV stuck almost closed	Check HPEV opening in EMS.	
	Dirty condenser coil	Clean.	
Low discharge pressure	Faulty condenser temperature regulation	Check condenser control operation.	
	Suction shutoff valve partially closed	Open valve.	
	Insufficient refrigerant in system	Check for leaks. Repair and add charge.	
	Low suction pressure	See corrective steps for low suction pressure.	
	Variable head pressure valve	Check valve setting.	
High suction pressure	Excessive load	Reduce load or add additional equipment.	
	Expansion valve overfeeding	Check remote bulb. Regulate superheat.	
Low suction pressure	Lack of refrigerant	1. Check for leaks. Repair and add charge.	
	2. Evaporator dirty or iced	2. Clean.	
	3. Clogged liquid line filter drier	3. Replace cartridge(s).	
	4. Clogged suction line or suction gas strainers	4. Clean strainers.	
	5. Expansion valve malfunctioning	5. Check and reset for proper superheat.	
	Condensing temperature too low	Check means for regulating condensing temperature.	
	Improper TXV	Check for proper sizing.	
Little or no oil pressure solenoid valve operation	Clogged suction oil strainer	Clean.	
	Excessive liquid in crankcase	Check crankcase heater.	
	Low oil pressure safety switch defective	Reset expansion line.	
	Worn oil pump	Replace.	
	Oil pump reversing gear stuck in wrong position	Reverse direction of compressor rotation. Replace compressor.	
	Worn bearings. Low oil level	Add oil and/or through defrost.	
	Loose fitting on oil lines	Check and tighten system.	
	Pump housing gasket leaks	Replace gasket.	
Compressor loses oil	Lack of refrigerant	Check for leaks and repair. Add refrigerant.	
	Excessive compression ring blow by	Replace compressor.	
	Refrigerant flood back	Maintain proper superheat at compressor.	
	Improper piping or traps	Correct piping.	

Table 6-3. Example Troubleshooting Process

**HFC**

MANUAL

**A**

***APPENDICES***



**KYSOR WARREN**  
eptarefrigeration

## APPENDIX A. STANDARD WARRANTY AND MANUAL DISCLAIMER

### A.1. STANDARD WARRANTY

This appendix contains the KWs standard warranty for its products and a disclaimer for this manual.

Seller warrants to its direct purchasers that Products, including Service Parts, shall be of a merchantable quality, free of defects in material or workmanship, under normal use and service for a period of one (1) year from date of original equipment start-up, or eighteen (18) months from date of shipment by Seller, whichever first occurs. This warranty runs to only the original purchaser of equipment or part. Any Products covered by this warranty found to Seller's satisfaction to be defective upon examination at Seller's factory will at Seller's option, be repaired or replaced and returned to Buyer via lowest common carrier FOB seller's point of shipment. This is buyer's sole and exclusive remedy and, except as provided in the next sentence, seller's sole and exclusive liability in connection with the warranty. Or Seller may at its option grant Buyer a credit for the purchase price of the defective Product. Buyer must prepay all costs for transportation of Products to Seller's factory.

Seller shall have no liability for expenses incurred for repairs made by Buyer except by prior, written authorization. Any claim under this warranty shall be made to Seller in writing within the warranty period above, otherwise such claim shall be deemed waived. Seller shall have no warranty obligation whatsoever if its products have been subjected to alteration, misuse, negligence, free chemicals in system, corrosive atmosphere, accident, or if operation is contrary to Seller's or manufacturer's recommendations, or if the serial number has been altered, defaced, or removed.

**This warranty is in lieu of all other warranties, expressed, implied or statutory, including, but not limited to any warranty of merchantability or fitness, and all other obligations or liabilities of seller are hereby disclaimed.**

#### WARRANTY NOTES

This equipment is designed to operate properly and produce rated capacity when installed in accordance with accepted industry standards. Failure to meet the following conditions may result in voiding of the system warranty:

1. System piping must be installed following industry standards for good piping practices (see details later in this document).
2. Inert gas (dry nitrogen) must be charged into piping during welding.
3. System must be thoroughly leak checked and evacuated before initial charging. High vacuum gauge capable of reading microns is mandatory--Dials indicating pressure gauges are not acceptable.
4. Power supply to system must meet the following conditions:
  - Voltage for 208/230 not less than 195 volts or more than 253 volts.
  - All other voltages must not exceed +/- 10% of nameplate ratings.
  - Phase imbalance not to exceed 2%.

5. All controls and safety switch circuits properly connected per wiring diagram.
6. Factory installed wiring must not be changed without written factory approval.

#### THIS WARRANTY SHALL NOT APPLY:

1. BULBS: Light bulbs, fluorescent lamp tubes and LEDs are not covered by any warranty for length of life or for any type of breakage.
2. To the condensing unit used with refrigerated equipment unless same was sold and shipped by Seller
3. When this equipment or any part thereof is damaged by accident, fire, flood act of God, alteration, abuse, misuse, tampering, when the original model and serial number plate has been altered, defaced, or removed or used other than the recommended application by Seller.
4. When this equipment or any part thereof is subject to operation on low, high or improper voltages. Low and high voltage is defined as more than a 5% drop below or 10% higher than name plate voltage ratings.

#### NOTE

Proper field supply voltage to the equipment is the responsibility of the owner (end user).

5. When this equipment or any part thereof is damaged, or when operation is impaired, due to failure to follow installation manual.

#### NOTE

Proper field supply voltage to the equipment is the responsibility of the owner (end user).

6. To equipment with final destinations unknown to seller as indicated on the original sales order.
7. To labor cost for repair or replacement of parts.
8. To special or expedited freight or shipping charges or to customs duties to any country.
9. If the Warranty holder fails to comply with all the provisions, terms and conditions of this Warranty.
10. Parts replaced under this Warranty are warranted only through the remainder of the original Warranty.
11. Extended Service Agreements are provided by a third party not affiliated with Seller. The services provided by the third party are subject to the terms and conditions of the Extended Service Agreements and Seller is not responsible for those services or the third party's performance of its obligations.

**It is expressly understood and agreed that seller shall not be liable to buyer, or any customer of buyer, for indirect, special, incidental, consequential or punitive damages, including loss of profits, additional labor costs, loss of refrigerants or food product, or any injury to person or property caused by defective material or parts or for any delay or misperformance in the performance due to causes beyond its control or for any**



**expenses incurred by reason of the use or misuse by buyer or third parties of the products. Seller's maximum liability for direct damages is limited to the amount paid by the buyer for the particular item of equipment or part involved.**

**NOTE**

In the constant effort to improve our products, we reserve the right to change at any time specifications, design, or prices without incurring obligation.

**COMPRESSOR WARRANTY**

Compressor replacements or exchanges shall be made through the nearest authorized wholesaler of the compressor manufacturer (not at Seller's factory) and no freight shall be allowed for transportation of the compressor to and from the wholesaler. The replacement compressor shall be identical to the model of the compressor being replaced

Additional charges which may be incurred throughout the substitution of other than identical replacements are not covered by this warranty. An optional, non-assignable, three (3) or four (4) year extended compressor warranty may be purchased within the boundaries of the United States of America, its territories and possessions, and Canada. With this extended compressor warranty, replacements are administered by an authorized compressor distributor only. Replacements within the first year of the warranty are available through the distributor, the second through fifth years, the purchaser must submit a proof-of-purchase of a compressor and supply it to Kysor Warren Epta US Warranty Claims for reimbursement.

**PARTS WARRANTY POLICY**

The following procedures are in accordance with the Kysor Warren Epta US standard one-year warranty, which covers any part to be free of defects under normal use and service for one year from the date of installation. (Not to exceed one year and 30 days from the date of original shipment from the factory.)

**In Warranty/Non-Warranty Parts Replacement**

When ordering Warranty replacement part(s), the following information must be furnished to the Parts Department via phone, or e-mail with purchase orders provided by Fax or e-mail only.

1. Full name and address of Company
2. Name and phone number of person ordering parts
3. Model number
4. Serial number
5. Factory order number
6. Description of parts desired
7. Original date of installation
8. Reason for replacement
9. Complete shipping address
10. Purchase order number

If the order is for a replacement still in warranty a Purchase Order Number will be required from the contractor placing the order. We will then issue a Return Material Authorization Tag (RMA) that will be sent to the firm or contractor who has ordered the part.

**NOTE**

All warranty replacements are shipped pre-paid fob shipping point. The warranty in effect for parts does not cover the cost of special freight terms – i.E. Ups next day, air freight, etc.

**Warranty of Replacement Parts**

Parts will be covered for the balance of the manufacturer's standard equipment warranty or 90 days from the date of shipment of the replacement part, whichever is longer.

If the order is for a replacement still in warranty a Purchase Order Number will be required from the contractor placing the order. We will then issue a Return Material Authorization Tag (RMA) that will be sent to the firm or contractor who has ordered the part.

**NOTE**

All warranty replacements are shipped pre-paid fob shipping point. The warranty in effect for parts does not cover the cost of special freight terms – i.E. Ups next day, air freight, etc.

**Purchase Parts Locally**

If you require an emergency Warranty replacement and you have to purchase the parts from a local supply house,

Kysor Warren Epta US will accept the return of the original part for replacement only. Should the locally purchased part(s) fail, it must be returned to the local supplier for replacement, repair or credit.

**Return Authorization Procedure**

When in-warranty replacement parts are shipped with the service order stating "warranty replacement, return replaced material within (45) forty-five days of shipping date or invoice will be rendered and payable", return is required. Credits will not be issued for parts returned after (45) forty-five days.

**WORK AUTHORIZATION PROCESS FOR WARRANTY LABOR**

All warranty labor claims must be approved in advance by an authorized Kysor Warren Epta US associate. Note: Only Technical Support associates and company officers are authorized to approve warranty labor. If labor is approved, the payee will be issued a written work authorization. All invoices submitted without a written work authorization are subject to denial. The following information is required for the issuance of a written work authorization:

- Model number (all involved), Serial number (all involved)
- Complete description of issues and corrections to be made
- A "Not to exceed" estimate for repairs

In case of after hour's emergency, you must contact the Technical Support Department at the beginning of the next business day.

Phone (800) 866-5596. Same info as above is still required.

The written work authorizations must be included with all invoices. Only written authorizations will be considered. E-mail approvals from authorized Kysor Warren Epta US associates are approved and should be included with invoices.

All invoices containing warranty parts not obtained from Kysor Warren Epta US Service Parts Department must be accompanied by the wholesaler's invoice for reimbursement or will be replaced through the Kysor Warren Epta US Service Parts Department. (Kysor Warren Epta US will pay only wholesale cost of parts if not supplied by Kysor Warren Epta US). All defective parts must be returned to Kysor Warren Epta US if so requested. (See Parts Warranty Policy)

Labor to change DOA compressors will be paid only with a teardown report from the compressor manufacturer, submitted with the invoice. (Note: Compressor must be factory defective as described in teardown report, before labor will be paid). Teardown reports have to be requested at the time of warranty exchange from an authorized wholesaler.

All model and serial numbers must be included on your invoice, (for all equipment serviced). For compressor warranty, the model and serial number of the unit the compressor was located and the model and serial number of the compressors – both old and new – must be included.

All invoices must be billed to Kysor Warren Epta US first party. Kysor Warren Epta US will not pay third party invoices. Emailed invoices and scans of backup are preferred and may speed processing.

Invoices submitted after 30 days from date when work was done will be subject to denial. Invoices submitted after 60 days from the date when work was done will be denied.

If you receive a notice requesting more information, (i.e. model, serial number, etc.), you will have an additional 30 days to respond. If a response is not received within 30 days, the invoice will be denied.

All warranties of the equipment are subject to standard manufacturer's warranty and terms and conditions of the sale. Any exception to the standard warranty policies must be specifically agreed to in writing by Kysor Warren Epta US prior to the date of sale.

All invoices must be billed to Kysor Warren Epta US, Attn: Technical Support Coordinator, 5201 Transport Boulevard, Columbus, GA 31907-8944. Phone (800) 866-5596.

Labor to replace parts damaged in transit (shipping damage) must be noted on the shipping bill before any labor charges will be considered for payment.

No warranties - This Manual is provided "as is" without any representations or warranties, express or implied. Kysor Warren Epta US makes no representations or warranties in relation to this Manual or the information and materials provided herein. Although we make a reasonable effort to include accurate and up to date information, without prejudice to the generality of this paragraph, Kysor Warren Epta US does not warrant that the information in this Manual is complete, true, accurate or non-misleading. The Kysor Warren Epta US HFC System Manual is provided solely for informational purposes. You

should not act upon information without consulting Kysor Warren Epta US, a distributor, subsidiary or appropriate professional.

**Limitations of liability** - Kysor Warren Epta US will not be liable to you (whether under the law of contract, the law of torts or otherwise) in relation to the contents of, or use of, or otherwise in connection with, this Manual:

- to the extent that this Manual is provided free-of-charge, for any direct loss;
- for any indirect, special or consequential loss; or
- for any business losses, loss of revenue, income, profits or anticipated savings, loss of contracts or business relationships, or loss of reputation or goodwill.

These limitations of liability apply even if Kysor Warren Epta US has been expressly advised of the potential loss.

#### NOTE

Installation and maintenance to be performed only by qualified personnel who are familiar with local codes and regulations, and experienced with this type of equipment. Sharp edges and coil surfaces are a potential injury hazard. Avoid contact with them.

#### WARNING

There may be more than one source of electrical current in this unit. Do not service before disconnecting all power supplies.

#### WARNING

All pertinent electrical codes and regulations must be strictly followed. Any deviations from these requirements will be strictly the responsibility of the installer.

## APPENDIX B. FORMS AND REPORTS

This appendice contains suggested forms and reports that operators can use when operating the system. Operators can, and should, modify/add/delete these forms and reports to satisfy their specific needs.

### RACK START-UP REPORT:

Submitted by:		When visited:	
Project manager:		Field hours:	
Customer:		Store:	
Sales order:		Address:	
Salesperson:		City, State:	
Date shipped:		Zip code:	

Store RH%		Refrigerant:	
Outside RH%		S00	
Rack serial number:		I/O manual	
Model number:		Parts manual	
Store Ambient Temp.		EMS population sheet	
Outside Ambient Temp.			

### COMPRESSORS:

Comp #	Core Sense Test	Amps L1	Amps L2	Amps L3	Crankcase heater amps	Demand Cooling Controller Test	Time Delay Set Point	HP Cut-out Set Point	HP Cut-out Mechanical Test	HP Cut-out Controller Test	Oil Pressure	Oil Level	Oil Mechanical Test	Oil Controller Test
1														
2														
3														
4														
5														
6														
7														
8														
9														
Any other comp. issue?														

**RACK CONTROLS**

	Controller Set Point	Mech. Set Point	Mechanical Test	Controller Test	Notes
Group 1 Low Pressure Control					
Group 2 Low Pressure Control					
Master High Pressure Control					
Receiver Pop-off					
Phase Loss Monitor					
Drop Leg Hold Back Valve					
Heat Reclaim - Electric					
Heat Reclaim - Ref					
Liquid Pressure Regulator					
Liquid Press Bypass Solenoid					
Receiver Level Indicator					
Receiver Level Alarm					
Receiver Bypass (surge)					
Receiver Pressure Regulator					
Oil Pressure Regulator					
Sub-cooler EPR					
Sub-cooler EV					
Sub-cooler LLSV 1					
Sub-cooler LLSV 2					
Oil filter diff switch: alarm & shut down					

**MISC CONTROLS:**

	Verify	Notes
LEGENDS: Does components on legends match rack build?		
I/O LIST: Does all I/O points match rack build?		

**MISC CONTROLS:**

	Test	Notes
Leak Detection System		
Case Lighting Contactor		
Condenser GFI outlet		
Exhaust fans		
Receiver heater		
Verify location & accuracy of all transducers (see I/O sheet)		
Verify location and accuracy of all sensors (see I/O sheet)		

**CIRCUITS: IF CONTROLLED BY RACK CONTROLLER.**

Circuit #	EEPR & LLSV Verified	Defrost Amps L1	Defrost Amps L2	Defrost Amps L3	Fan Amps L1	Fan Amps L2	Fan Amps L3	Case Lights
1								
2								
3								
4								
5								
6								
7								
8								
9								
10								
11								
12								
13								
14								
15								

**CONDENSER:**

Serial number:	
Model number:	
Number of fans:	
Amps per fan:	
Fan voltage	

FULL CONDENSER CHECKLIST:	YES	NO
Fans rotating proper direction:		
Condenser pump out de-energized:		
50% solenoid valve de-energized:		

50% split condenser checklist:	YES	NO
Fans rotating proper direction:		
Condenser pump out de-energized:		
50% solenoid valve de-energized:		

**VFD INFORMATION:**

Serial number:		
Model number:		
Program resides in: VFD		
Program resides in: Rack Controller		
	YES	NO
Correct program:		
Is VFD set up properly to communicate with Controller		
Is Comm loop to Controller grounded?		
Controlling sensor drop leg:		
Independent ambient sensor:		
Speed ramps up and down properly:		



**KYSOR WARREN**  
eptarefrigeration

5201 Transport Blvd. • Columbus, GA 31907  
Toll-Free: 800.866.5596 • Phone: 706.568.1514  
[www.kysorwarren.com](http://www.kysorwarren.com)

