

GRANBERING US

LOW TEMPERATURE REACH-IN
MERCHANDISER



KYSOR WARREN
eptarefrigeration

TECHNICAL INFORMATION

KWN5F

Capacities	2 Doors	3 Doors	4 Doors	5 Doors
Total Display Area (ft ²)	25.53	38.30	51.06	63.83
Cubic Capacity (ft ³)	53.87	80.40	107.20	134.00
Max Shelf Depth (Top/Bottom) (in)	22/22	22/22	22/22	22/22
Weight (.lbs)	882	1257	1609	2094

Refrigeration Data (All data is per side)				
Evaporator Temperature (°F) <i>Frozen Food/Ice Cream</i>	-10/-19	-10/-19	-10/-19	-10/-19
Discharge Air Temperature (°F) <i>Frozen Food/Ice Cream</i>	-2 to -2.5/ -12 to -13	-2 to -2.5/ -12 to -13	-2 to -2.5/ -12 to -13	-2 to -2.5/ -12 to -13
Discharge Air Velocity (fpm)	300 - 400	300 - 400	300 - 400	300 - 400
Fan Speed (rpm)	2100	2100	2100	2100
Parallel Thermal Load (Btuh) <i>Frozen Food/Ice Cream</i>	1784/1900	2676/2850	3568/3800	4460/4749
Conventional Thermal Load (Btuh) <i>Frozen Food/Ice Cream</i>	1821/1939	2731/2909	3642/3878	4552/4848
Superheat Setpoint (°F)	6 - 8	6 - 8	6 - 8	6 - 8
Estimated Refrigerant Charge (.lbs)	1.335	2.214	3.094	3.974

Electrical Data (Amps/Qty)				
115V/60Hz, 1 Phase <i>Fans</i>	0.94	1.41	1.88	2.35
LED <i>GE ELV2</i>	0.26	0.39	0.52	0.65
Anti-Sweat Heater Amps (F.F.)	1.53	2.28	3.02	3.76
Drain Heater <i>Electric</i>	N/A	N/A	N/A	N/A
208V/60Hz, 3 Phase <i>Defrost Heater</i>	2.54	4.23	5.92	7.61

Defrost Data	Per Day	Fail Safe (min) ¹	Termination (°F)	Drip Time (min)
Electric	1	25	59	10

¹ At ASHRAE conditions. For conditions above 75F, 55% RH, increase defrost time by 15 min.
Type I refrigerator, intended for use in an area where the environmental conditions are controlled and maintained that conditions do not exceed 75°F and 55% relative humidity.
Epta Refrigeration, whose policy is one of continuous improvement, reserves the right to change at any time specifications, designs, or prices without incurring obligation.
2017 DOE Compliant

GRANBERING US

LOW TEMPERATURE REACH-IN
MERCHANDISER



KYSOR WARREN
eptarefrigeration

TECHNICAL INFORMATION

KWN5F - END CASE

Capacities	3 Doors
Total Display Area (ft ²)	30.64
Cubic Capacity (ft ³)	66.02
Max Shelf Depth (Top/Bottom) (in)	22/22
Weight (.lbs)	972

Refrigeration Data (All data is per side)	
Evaporator Temperature (°F) <i>Frozen Food/Ice Cream</i>	-10/-19
Discharge Air Temperature (°F) <i>Frozen Food/Ice Cream</i>	-2 to -2.5/-12 to -13
Discharge Air Velocity (fpm)	300 - 400
Fan Speed (rpm)	2100
Parallel Thermal Load (Btuh) <i>Frozen Food/Ice Cream</i>	2230/2375
Conventional Thermal Load (Btuh) <i>Frozen Food /Ice Cream</i>	2276/2424
Superheat Setpoint (°F)	6 - 8
Estimated Refrigerant Charge (.lbs)	1.741

Electrical Data (Amps/Qty)	
115V/60Hz, 1 Phase <i>Fans</i>	1.41
LED <i>GE ELV2</i>	0.39
Anti-Sweat Heater Amps (F.F.)	2.14
Drain Heater <i>Electric</i>	N/A
208V/60Hz, 3 Phase <i>Defrost Heater</i>	3.32

Defrost Data	Per Day	Fail Safe (min) ¹	Termination (°F)	Drip Time (min)
Electric	1	25	59	10

¹ At ASHRAE conditions. For conditions above 75F, 55% RH, increase defrost time by 15 min.
Type I refrigerator, intended for use in an area where the environmental conditions are controlled and maintained that conditions do not exceed 75°F and 55% relative humidity.
Epta Refrigeration, whose policy is one of continuous improvement, reserves the right to change at any time specifications, designs, or prices without incurring obligation.
2017 DOE Compliant

GRANBERING US

LOW TEMPERATURE REACH-IN MERCHANDISER



KYSOR WARREN
eptarefrigeration

PROFILE VIEW

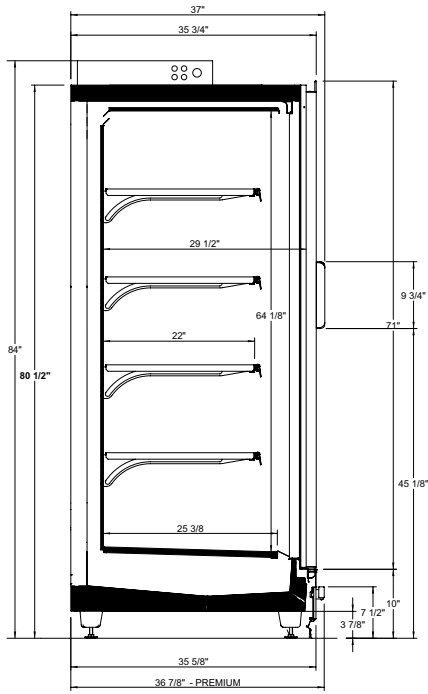

KWN5

SECTION VIEWS

